

Autonics

TEMPERATURE CONTROLLER
TC3YF SERIES

M A N U A L



Thank you very much for selecting Autonics products.
For your safety, please read the following before using.

Caution for your safety

- Please keep these instructions and review them before using this unit.
- Please observe the cautions that follow:
 - Warning** Serious injury may result if instructions are not followed.
 - Caution** Product may be damaged, or injury may result if instructions are not followed.
- The following is an explanation of the symbols used in the operation manual.
 - ▲ caution: Injury or danger may occur under special conditions.

Warning

- In case of using this unit with machineries(Nuclear power control, medical equipment, vehicle, train, airplane, combustion apparatus, entertainment or safety device etc), it requires installing fail-safe device, or contact us for information on type required. It may result in serious damage, fire or human injury
- It must be mounted on Panel. It may give an electric shock.
- Do not connect terminals when it is power on. It may give an electric shock.
- Before connecting power, check the terminal number. It may cause a fire.
- Do not disassemble and modify this unit, when it requires. If needs, please contact us. It may give an electric shock and cause a fire.

Caution

- This unit shall not be used outdoors. It might shorten the life cycle of the product or give an electric shock.
- For wire connection, AWG No. 12~28 should be used and screw bolt on terminal block with 0.3N · m to 0.4N · m strength. It may result in fire due to contact failure.
- Please observe specification rating. It might shorten the life cycle of the product and cause a fire.
- Do not use the load beyond rated switching capacity of Relay contact. It may cause insulation failure, contact melt, contact failure, relay broken, fire etc.
- In cleaning the unit, do not use water or an oil-based detergent. It might cause an electric shock or fire that will result in damage to the product.
- Do not use this unit at place where there are flammable or explosive gas, humidity, direct ray the sun, radiant heat, vibration, impact etc. It may cause explosion.
- Do not inflow dust or wire dregs into inside of this unit. It may cause a fire or mechanical trouble.
- Before connecting wires, check the terminal polarity. It may cause a fire or explosion.

Front panel identification

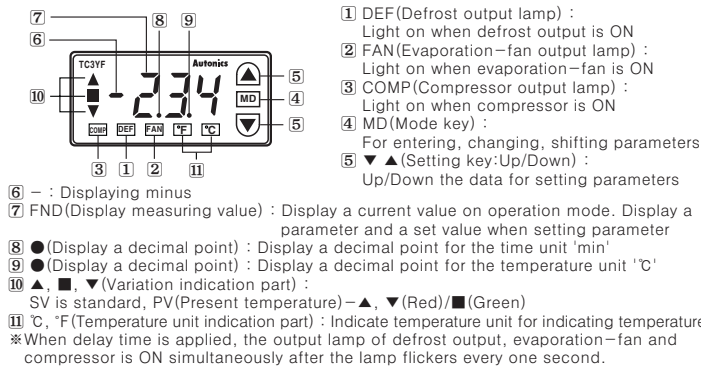

Dimensions

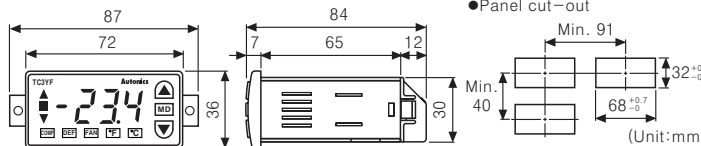

Connections

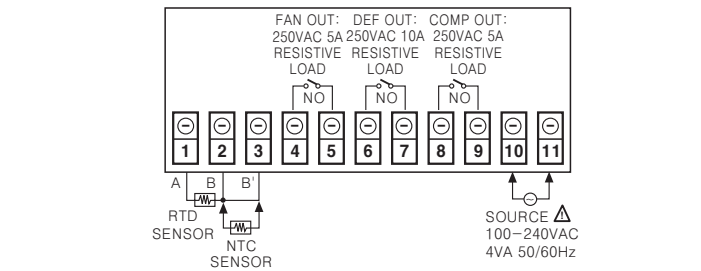

Functions

- Adjustable Hysteresis [HYS]**
 - This product controls compressor output by ON/OFF control type.
 - Frequent ON/OFF output causes noise and chattering. Proper interval on ON/OFF control prevents it and a malfunction on contact and compressor.
 - Ex) Setting value(SV) : -20°C, Hysteresis(HYS) : 1
 When current temperature is -19°C, compressor outputs ON.
 When current temperature is -21°C, compressor outputs OFF.
 - ON/OFF control is also called 2-position control because of OFF output for low temperature and ON output for high temperature with a target value.
- Input correction [Inb]**
 - This model corrects the error, which is occurred by inputted signal.
 - When measuring a temperature, it corrects the error occurred by disturbance or extended wire.
 - The corrected temperature and set value is compared for the operation.
 - Ex) Current temperature : -18°C, Display value : -20°C
 When setting Inb as 2, display value will be -18°C.
- Defrost function**
 - When compressor drives for long time, heat efficiency is lowered because evaporator and refrigerator are frozen. In this case, it is called defrost function for removing ice and frost.
 - Heating defrost method
 After mounting heater around evaporator, operate the heater with defrost period and defrost time setting of controller and remove frost.
 - Manual defrost method
 It operates defrosting for setting defrost time when press ▲ for 3sec during driving the compressor. When pressing ▼ for 3sec, defrost function is stopped, defrost output is turned to OFF and setting defrost period is restarted from OFF.
 After operating defrost for setting defrost time, setting defrost period is restarted.
 In case defrost period is "00", manual defrosting is operated only.
- Relay output**
 - Relay output is operating for ON/OFF output by using relay contact. It repeats ON/OFF the load in order to heating or cooling operation continuously. In this case, drive magnetic S/W or power relay(big capacity) can be used by using relay contact.
 - For using relay contact, do not exceed relay capacity.
 - Otherwise a relay can be damaged and it can cause fire.
 - When using relay contact to control main relay or magnetic switch, please use surge absorber in order not to inflow of counter electromotive force, caused from the coil of relay and magnet, into the inner body.
 - Life cycle of relay(electrical/mechanical) is indicated in "Specifications". Please design the system after checking the life cycle of relay.
 - The above specification are changeable without notice anytime.

Ordering information

	TC	3	Y	F	-	□	4	R
	①	②	③	④	⑤	⑥	⑦	
①Item	TC	Temperature Controller						
②Digit	3	999(Digit)						
③Size	Y	DIN W72×H36mm						
④Refrigeration control	F	Freezing						
⑤Sub output	1	Compressor						
	2	Compressor+Defrost output						
	3	Compressor+Defrost output+Evaporation-fan output						
⑥Power supply	4	100~240VAC 50/60Hz						
⑦Output	R	Relay output						

Specifications

Model	TC3YF-14R(★1)	TC3YF-24R	TC3YF-34R
Power supply	100~240VAC 50/60Hz		
Allowable voltage range	90 to 110% of rated voltage		
Power consumption	4VA		
Indication method	7Segment LED Display(Red)		
Display	NTC : -40.0~99.9°C(40~212°F), RTD : -99.9~99.9°C(-148~212°F)		
Display method	[PV ±0.5% or 1°C Max.] rdg ±1digit(Room temperature : 23 ±5°C)		
Sampling period	Min. 0.5sec		
Input sensor	NTC : Thermistor, RTD : DPT 100Ω(★2)		
Input of line resistance	Tolerance line resistance is max. 5Ω		
Control method	ON/OFF control:Adjustment sensitivity(HYS) variable(0.5~5.0°C, 2~50°F)		
Control output	Compressor (250VAC 5A 1a)	Compressor (250VAC 5A 1a) Defrost output (250VAC 10A 1a)	Compressor(250VAC 5A 1a) Defrost output (250VAC 10A 1a) +Evaporation-fan output (250VAC 5A 1a)
Insulation resistance	Min. 100MΩ(at 50VDC)		
Dielectric strength	2000VAC 60Hz for 1 minute(between external terminal and case)		
Noise strength	±2kV R-phase and S-phase(pulse width 1μs)		
Memory retention	Approx. 10 years(When using non-volatile semiconductor memory type)		
Relay life cycle	COMP	Mechanical : Min.20,000,000 times Electrical : Min.50,000 times(250VAC 5A resistive load)	
	DEF	Mechanical : Min.20,000,000 times Electrical : Min.100,000 times(250VAC 10A resistive load)	
	FAN	Mechanical : Min.20,000,000 times Electrical : Min.50,000 times(250VAC 5A resistive load)	
Vibration	Mechanical	0.75mm amplitude at frequency of 10 to 55Hz in each of X, Y, Z directions for 2 hours	
	Malfunction	0.5mm amplitude at frequency of 10 to 55Hz in each of X, Y, Z directions for 10 minutes	
Ambient temperature	-10 ~ 50°C(at non-freezing status)		
Storage temperature	-20 ~ 60°C(at non-freezing status)		
Ambient humidity	35 ~ 85%RH		
Weight	Approx. 143g		

*Indication accuracy of section except for room temperature is ambient temperature range : [The bigger one between PV ±0.5% or 1°C] rdg ±1°C
 *(★1)There is no relay point of contract output where defrost lamp is lighted for 14R.
 *(★2)RTD is optional.

SV checking and setting

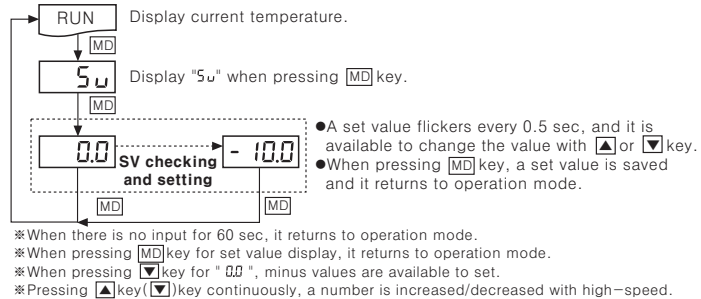

Flow chart for first setting group

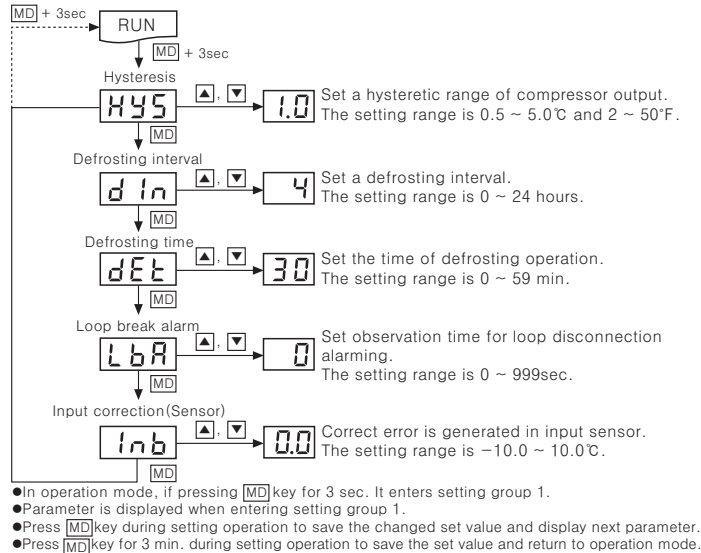

Flow chart for second setting group

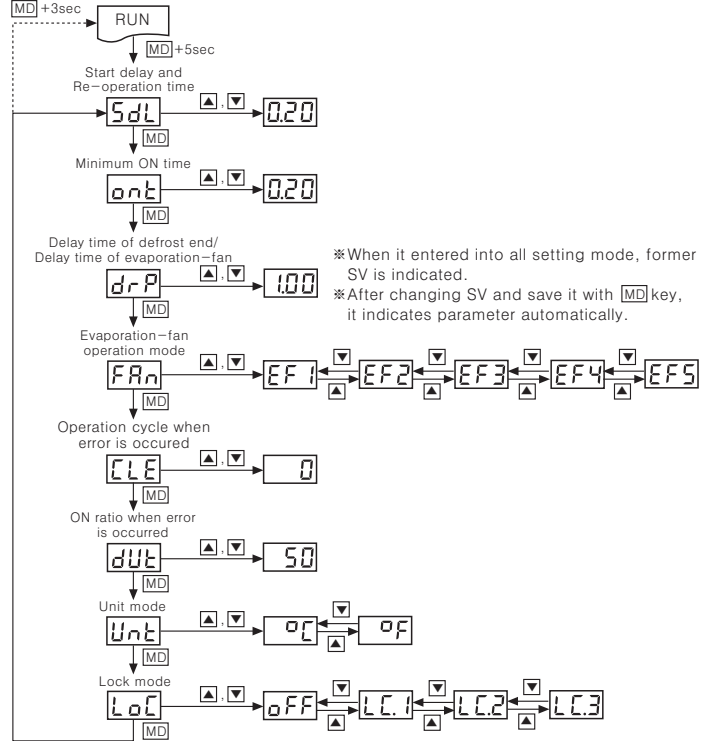

Input specification and range

Input sensor	Using range	
	°C	°F
RTD(DPT 100Ω)	-99.9 ~ 99.9	-148 ~ 212
Thermistor	-40.0 ~ 99.9	-40 ~ 212

*A temperature sensor converts temperature into electric signal, and a temperature controller measures the temperature in order to do ON/OFF the control output.
 *The setting is available within using range, and set range is fixed with using range.

Operation

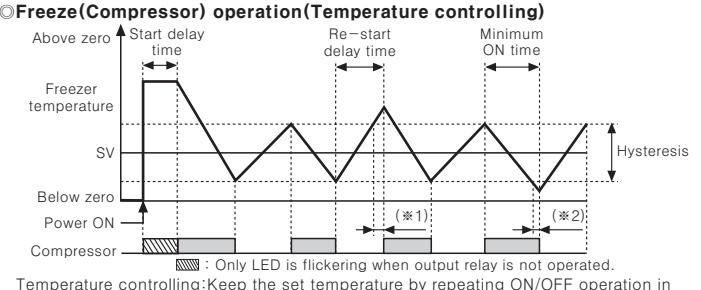

Start delay and re-operation time and re-start delay time [5dL]

- Start delay(Setting range:0m10s~9m59s)
 When apply the power again on a compressor after power is failed, the compressor will be under overload. In this case, start delay function prevents curtailing of the life cycle of a compressor.
- Re-start delay time(Setting range:0m10s~9m59s)
 It does not operate within re-start delay time after compressor OFF to prevent frequent ON/OFF.
- (※1)For start delay time, compressor output is OFF even when PV(Process Value) is lower than SV(Set Value). It is turned to ON after re-start delay time.
- The output lamp is ON simultaneously after the lamp flickers every one second during delay time.

Minimum ON time [onL]

- Set a minimum ON time to prevent frequent ON/OFF.
 (※2)Compressor output is ON even when PV(Process Value) is lower than SV(Set Value). It is turned to ON after the minimum ON term.

Defrosting operation(Heating defrost method)

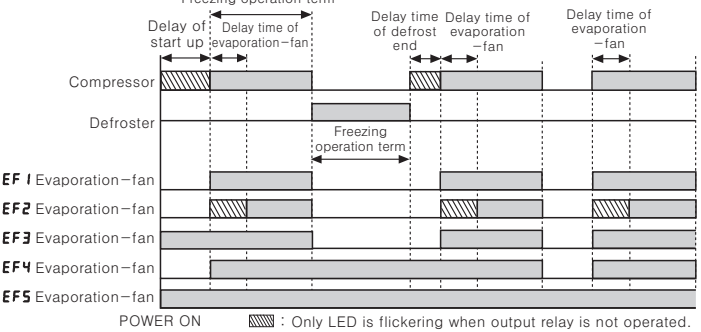

Defrost Interval [dIn]

Start defrosting for relevant interval. (Setting range:0~24hour)

Defrost Time [dEt]

Defroster(heater) is ON during defrost time. (Setting range:0~59m)

Delay time of defrost end/Delay time of evaporation-fan operation [Dripping Time : d-rP]

- Delay time of defrosting end
 It is the time from drops are fallen down to the drops are drained. After drops are drained, compressor starts operating. (Setting range:0m00s~5m59s)
- Delay time of evaporation-fan operation
 To improve the efficiency of frosting, the time of evaporation-fan operation is delayed until evaporation plate is frozen after compressor operating. (Setting range:0m00s~5m59s)
- The delay time of defrosting end and the delay time of evaporation-fan operation are used independently with one setting time(d-rP).
- When the delay time of defrosting end is finished, defrosting is discontinued and defrosting interval is repeated.
- The output lamp is ON simultaneously after the lamp flickers every one second during delay time.

Evaporation-fan operation mode [FRn]

- Operation mode 1[EF1] : Operate at the same time with compressor. OFF for defrost operation.
- Operation mode 2[EF2] : Operate after the delay time of evaporation-fan operation. OFF for defrost operation.
- Operation mode 3[EF3] : Keep operating even after compress OFF. OFF only for defrost operation.
- Operation mode 4[EF4] : It maintains former output status during compressor ON or defrost operation and delay time of defrost end. The output will be OFF when compressor output and defrost output is OFF. (for controlling higher than zero point)
- Operation mode 5[EF5] : Operate right after inputting power.

Error display

- Err mark and error content are flickering every 0.5 sec. when error is occurred.
 - Display Error
- | | |
|---------|--|
| Err oPn | Input sensor disconnected(Operate after connecting sensor) |
| Err LbR | Input sensor is normal or refrigerator temperature change is in 1°C or 2°F for observation time of loop disconnection. |
| Err LLL | Measured sensor input is lower than displayed range |
| Err HHH | Measured sensor input is higher than displayed range |
- *For the Errors(oPn/LLL/HHH), after solving the problems(Connecting sensor/Changing measured value within displayed range), it operates normally.
 *For Error(LbA), if press both ▲ and ▼ key for 3 sec. after checking compressor, it operates normally. When LbA is 0, the function is OFF.

Compressor operation for error

- Controller does not operate normally in error.
- To protect the inside of compressor, compressor keeps repetitive operation until error is removed.
- The cycle of compressor operation in error[CLE]
 Compressor operates ON/OFF during set operation cycle.
- The ratio of compressor ON in erro[dUL]
 During set operation cycle, compressor operates ON as much as set ratio.
- The operation cycle of compressor is "0".
 When error is occurred, ON/OFF cycle is not operated and compressor operation is OFF. Compressor ON ratio (100%) parameter is not displayed.
- The ratio of compressor ON is "100". Compressor is ON when error is occurred.

Lock function [LoC]

- Limit the change of SV and parameter
- oFF : Lock off
 LoC.1 : Setting group 2 Lock
 LoC.2 : Setting group 1, Setting group 2 Lock
 LoC.3 : Setting group 1, Setting group 2, Set value Lock

Factory default

First setting group				Second setting group			
Mode	Setting value	Mode	Setting value	Mode	Setting value	Mode	Setting value
HYS	1.0	LbR	0	SdL	0.20	CLE	0
dIn	4	Inb	0.0	onL	0.20	dUL	50
dEt	30			d-rP	1.00	UnL	°C
				FRn	EF1	LoC	oFF

●Setting value(Sv)
 Mode Setting value
 Sv 0.0

Caution for using

- Installation environment
 - ①It shall be used indoor.
 - ②Altitude Max. 2000m.
 - ③Pollution Degree 2.
 - ④Installation Category II.
 - Please use separated line from high voltage line or power line in order to avoid inductive noise.
 - Please install power switch or circuit-breaker in order to cut power supply off.
 - The switch or circuit-breaker should be installed near by users.
 - Do not use this product as Volt-meter or Ampere-meter, this is a temperature controller.
 - In case of using RTD sensor, 3wire type must be used. If you need to extend the line, 3wires must be used with the same thickness as the line. It might cause the deviation of temperature if the resistance of line is different.
 - In case of making power line and input signal line close, line filter for noise protection should be installed at power line and input signal line should be shielded.
 - Keep away from the high frequency instruments. (High frequency welding machine & sewing machine, big capacitive SCR controller)
- *It may cause malfunction if above instructions are not followed.

Main products

- COUNTER
- TIMER
- TEMPERATURE CONTROLLER
- PANEL METER
- TACHO/LINE SPEED/PULSE METER
- DISPLAY UNIT
- PROXIMITY SENSOR
- PHOTOELECTRIC SENSOR
- FIBER OPTIC SENSOR
- PRESSURE SENSOR
- ROTARY ENCODER
- SENSOR CONTROLLER
- POWER CONTROLLER
- STEPPING MOTOR & DRIVER & CONTROLLER
- LASER MARKING SYSTEM(CO₂, Nd:YAG)

Autonics Corporation
 http://www.autonics.com
Satisfiable Partner For Factory Automation

●HEADQUARTERS : 41-5, Yongdang-ri, Ungsang-eup, Yangsan-si, Gyeongsang, 626-847, Korea
 ●INTERNATIONAL SALES : Bldg. 402 3rd Fl., Bucheon Techno Park, 193, Yaksdae-dong, Wornji-gu, Bucheon-si, Gyeonggi-do, 420-734, Korea
 TEL: 82-32-329-0722 / FAX: 82-32-329-0728
 ●E-mail : sales@autonics.net