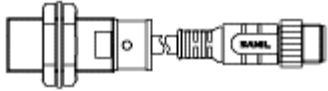
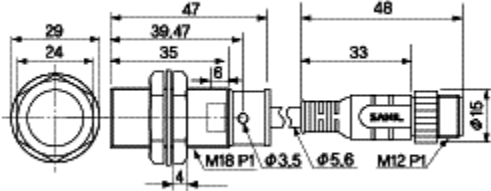

SPECIFICATIONS

Outer shape	Model	Sensing distance(m/m)	Output	Response frequency	Power source
18Ø 	SJ-18MSW	5	NPN NO	350 Hz	DC 10~30V

OUTLINE DIMENSIONS

Model	Shield type
SJ-18MSW	

Sensing Fields(Typical)

If detecting target with a smaller size than the standard target, the sensing distance will become shorter.

