

- > **Soft-Start/Stop Controller and SSR in One Package**
- > **Microcontroller Based Technology**
- > **Adjustable Ramp Rates**
- > **Low Voltage, 4-20mA, or Potentiometer Control**
- > **LED Status Indicator**
- > **SCR Based Output Load Switching**
- > **Built-In Internal Snubber**



GENERAL SPECIFICATIONS

Dielectric Strength 50/60Hz, Input/Output/Base	4000 Vrms
Insulation Resistance (Min.) @ 500 Vdc	10 ⁹ Ohm
Max. Capacitance Input/Output	10 pF
Ambient Operating Temperature Range	-20 to 80°C
Ambient Storage Temperature Range	-40 to 125°C

MECHANICAL SPECIFICATIONS

Weight: (typical)	3.0 oz. (86.5g)
Encapsulation	Thermally Conductive Epoxy
Terminals - Power	Screws and Saddle Clamps Furnished, Unmounted
Control	Barrier Strip Screw Terminals

OUTPUT SPECIFICATIONS

	Voltage Suffix		
	12	24	48
Operating Voltage (47-63 Hz) [Vrms]	48-140	180-280	300-530
Transient Overvoltage [Vpk]	400	600	1200
Max. Off-State Leakage Current @ Rated Voltage [mA]	5	7	12
Power Factor (Min.) with Max. Load	0.5	0.5	0.5
Maximum Voltage Drop (100% On) [Vpk]	1.6	1.6	1.6
Minimum Off-State dv/dt [V/μsec]	200	200	200
	Current Suffix		
	25 Amp	50 Amp	90 Amp
Max. Load Current [Arms]	25	50	90
Min. Load Current (mArms)	150	150	150
Max. Surge Current (16.6ms) [Apk]	250	625	1200
Thermal Resistance Junction to Case (R _{θJC}) [°C/W]	1.02	0.63	0.28
Maximum I _t for Fusing, (8.3 msec.) [A _s]	260	1620	6000
	ST	SP	SS
	Max. Turn-On Time High Level P3	Adjustable	1/2 Cycle
Max. Turn-Off Time High Level P3	1/2 Cycle	Adjustable	Adjustable

INPUT SPECIFICATIONS*

	Minimum	Typical	Maximum
DC Voltage Supply Range [Vdc] [P1]	8	12	32
Input Current [mA]	28		30
Control Must Operate Voltage "ON" [Vdc][P3]	5		32
Control Must Release Voltage "OFF" [Vdc][P3]	0		4
Input Current [mA] [P3]	0		2.6
Analog Range Option A [Vdc][P4]	0.5		5
Analog Range Option B [Vdc][P4]	1.25		7
Analog Range Option C [Vdc][P4]	2		10
Analog Range Option D [mA][P4]	4		20
Nominal Input Impedance Option A,B,C [Ohms][P4]		20K	
Nominal Input Impedance Option D [Ohms][P4]		220	

*Voltages are reference to GND (Ground = 0Vdc) P2

The MCST, MCSP and MCSS series of controls is designed to provide adjustable surge reducing soft-start and soft-stop control for any load which would benefit from a gradual application or shutdown of power, and provide Crydom SSR switching within one package.

The MCS Controls are available with either soft-start, or soft-stop functions separately, or as a combined soft-start/soft-stop control. With adjustable ramp times from 100ms to 10 seconds in two ranges, these controls are ideal for reducing starting current surges in motors, in preventing saturation when switching transformers, or in reducing reverse EMF surges when de-energizing large inductive loads. Incorporating 4000 volt isolation from input to output, the MCS series allows real time adjustment of the ramp rates from a remote source using analog voltage or current control. Once the desired ramp rate is set using the analog input, a simple digital signal applied to the ON/OFF control input will operate the control. The MCS is also available with a built-in potentiometer for use where remote or continuous adjustment is not needed.

Part Number Nomenclature

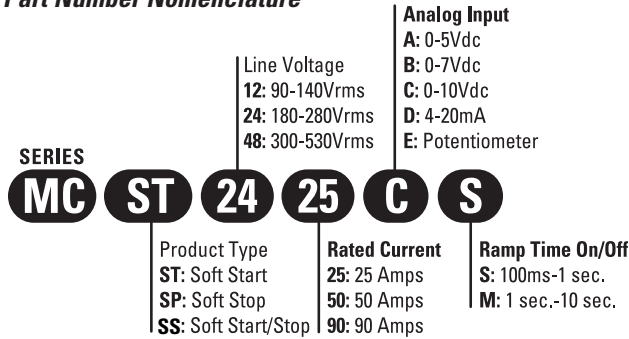

Output Status Functions

CONDITIONS	LED
Initial Logic Supply On	Flash Once
Load Voltage Missing / Load Open (w/control P3 disabled)	Flash Once Intermittently
Load Voltage Present (w/control P3 enabled)	Off
Ramp Time (Soft Start upon P3 Enable)	Off to Bright
Ramp Time (Soft Start upon P3 Disable)	Bright to Off
Output ON (Normally Steady Operation)	On

Electrical Connections

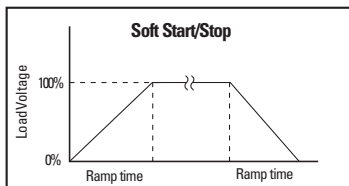
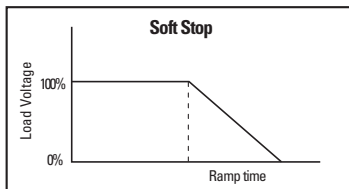
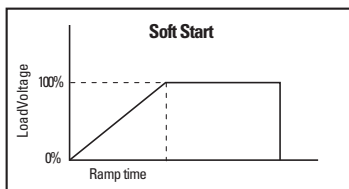
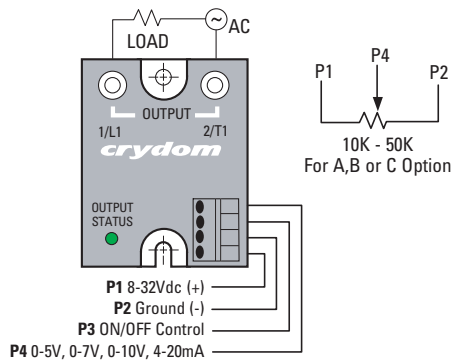

Mechanical

Dimensions are in inches (millimeters)

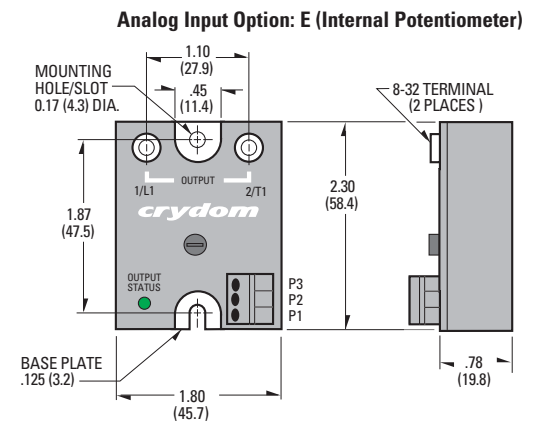
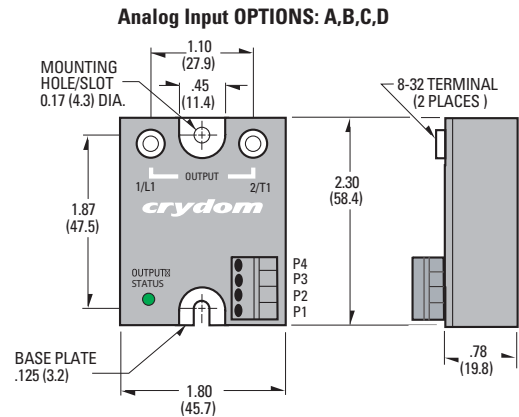

Screw Torque Requirements

8-32 Screws - 20in. lbs. (Screws dry without grease.)
 Input Connections via Screw Type Barrier Strip

Ramp Time in Seconds

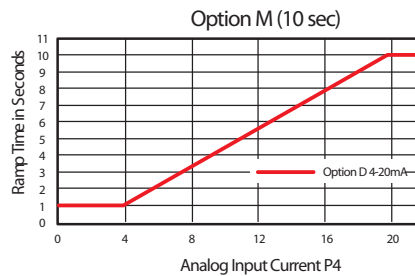
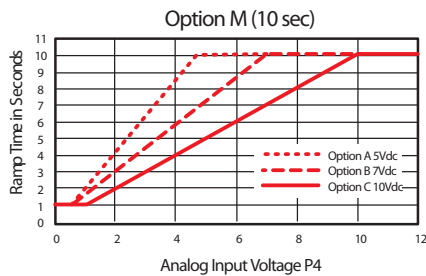
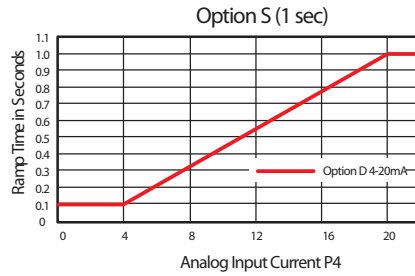
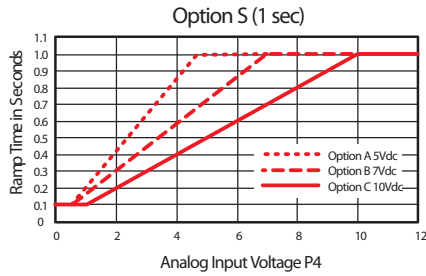

Current Derating Curves

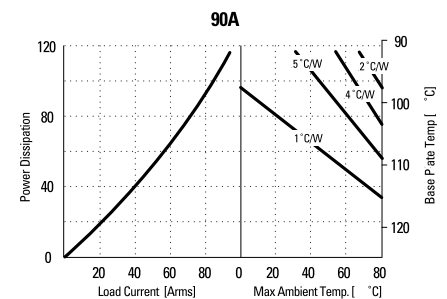
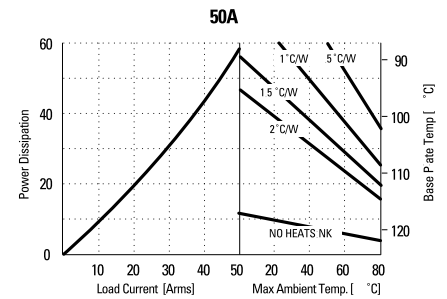
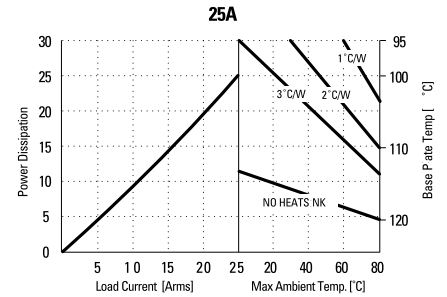

ISO9001 Certified

Approvals

UL - Pending



For recommended applications and more information contact:
USA: Sales Support (877) 502-5500 **Tech Support** (877) 702-7700 FAX (619) 710-8540
 Crydom Inc., 2320 Paseo de las Americas, Ste. 201, San Diego, CA 92154
Email: sales@crydom.com **WEB SITE:** http://www.crydom.com
UK: +44 (0)1202 606030 • **FAX** +44 (0)1202 606035 Crydom SSR Ltd., Arena Business Centre,
 Holyrood Close, Poole, Dorset BH17 7FJ, Email: intsales@crydom.com.
GERMANY: +49 (0)180 3000 506

ANNEX – ENVIRONMENTAL INFORMATION:

The environmental information disclosed in this annex including the EIP Pollution logo are in compliance with People's Republic of China Electronic Industry Standard SJ/T11364 – 2006, Marking for Control of Pollution Caused by Electronic Information Products.

Part Name	Toxic or hazardous Substance and Elements					
	Lead (Pb)	Mercury (Hg)	Cadmium (Cd)	Hexavalent Chromium (Cr (VI))	Polybrominated biphenyls (PBB)	Polybrominated diphenyl ethers (PBDE)
Semiconductor die	X	O	O	O	O	O
Solder	X	O	O	O	O	O

附件 - 环保信息:

此附件所标示的包括电子信息产品污染图标的环保信息符合中华人民共和国电子行业标准 **SJ/T11364 - 2006**, 电子信息产品污染控制标识要求

部件名称	有毒有害物质或元素					
	铅 (Pb)	汞 (Hg)	镉 (Cd)	六价铬 (Cr (VI))	多溴联苯 (PBB)	多溴二苯醚 (PBDE)
半导体芯片	X	O	O	O	O	O
焊接点	X	O	O	O	O	O

