

Dimensions

(Unit : mm)

A Size : DPU3□A – 25 / 50

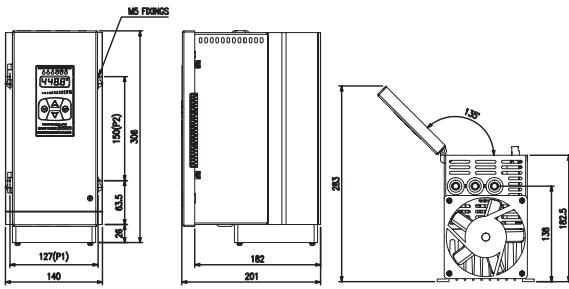

B Size : DPU3□B – 70 / 100 / 150 / 180 / 200

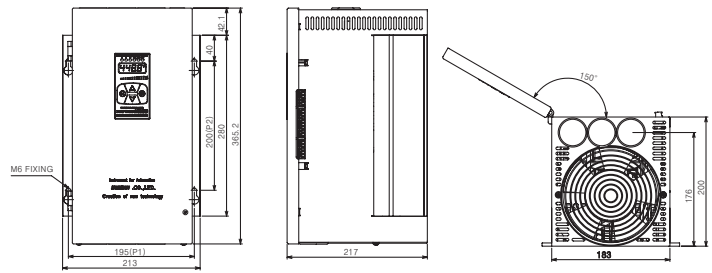

C Size : DPU3□A – 250 / 400

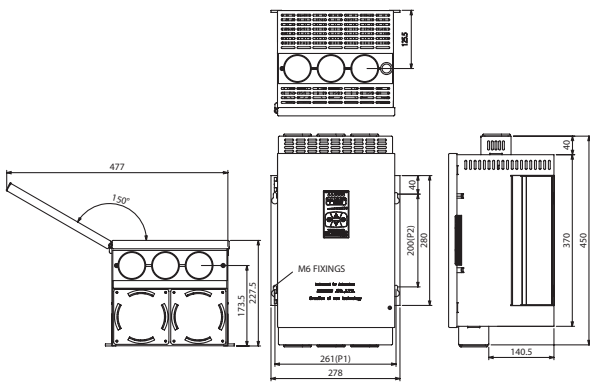

D Size : DPU3□B – 500 / 600 / 750 / 950

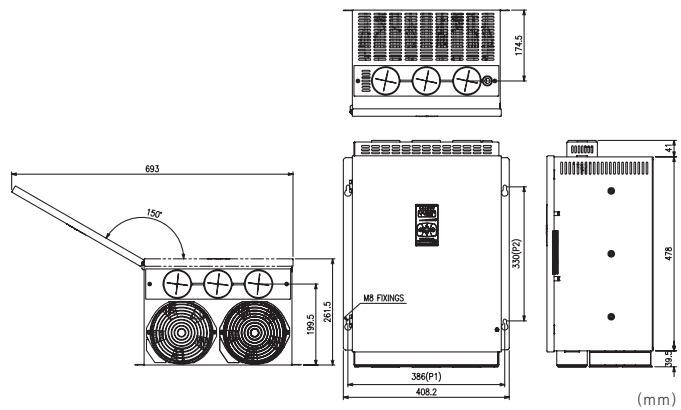

Connections

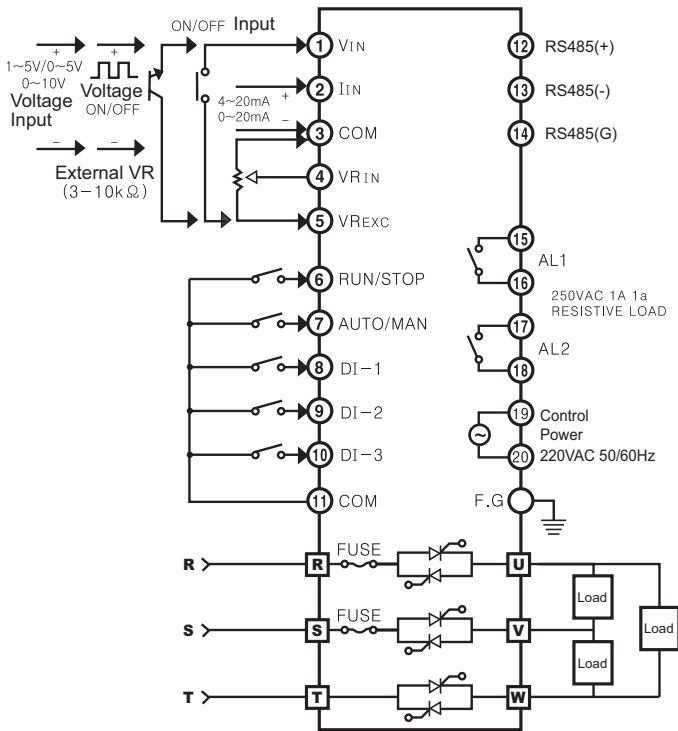

Functions

• Control method [CONTROL Method : $\angle - Rd$]

Control method	Control mode	Parameter
Phase Angle Control	NORMAL mode	PR
	Static voltage mode	$u-Fb$
	Static current mode	$\angle-Fb$
	Static power mode	$y-Fb$
Cycle control	Fixed cycle control	$F-\angle y$
	Variable cycle control	$u-\angle y$
	ON/OFF control	$onof$

① NORMAL Mode (Phase Angle without feedback) [Pr]

- As normal output method, control angle is divided proportionally depending on control input signal.
- Following diagram is indicating the feature of output and insufficient power and over-current can be generated based on the middle position of control input.

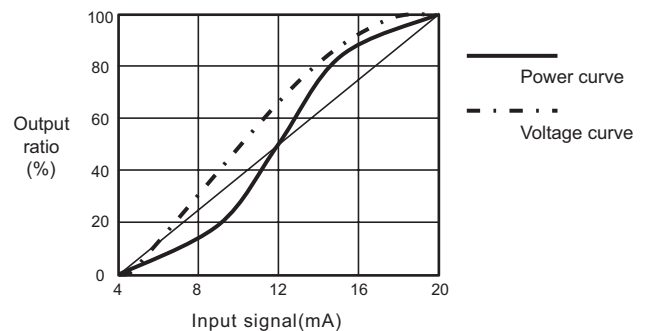

A	Recorders
B	Data Loggers
C	Indicators
D	Converters
E	Controllers
F	Thyristor Units
G	Transmitters
H	Temp. Sensors
I	Thermo Meters
J	Pressure Gauges
K	Others

DPU series (1Phase)

DPU series (3Phase)

SPU

ZPU

LM-200/LP100

② Static voltage Mode (Voltage-Feedback) [V-Fb]

- As temperature coefficient of electric resistance is short of load (iron, chromium, nichrome, etc), Static voltage Mode outputs regular voltage of being in proportion to control input for load resistance fluctuation so as not to change output voltage.

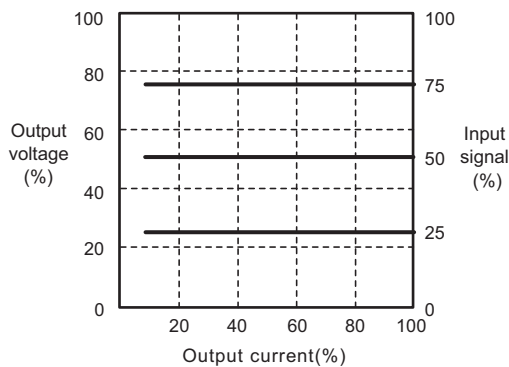
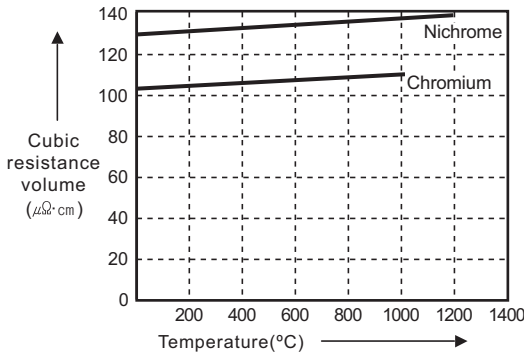

③ Static current Mode (Current-Feedback) [I-Fb]

- As temperature coefficient of electric resistance is load (iron, chromium, nichrome, etc), largely changed as 6~12 times by standardizing normal temperature, Static voltage Mode outputs regular voltage of being in proportion to control input for load resistance fluctuation so as not to change output voltage.

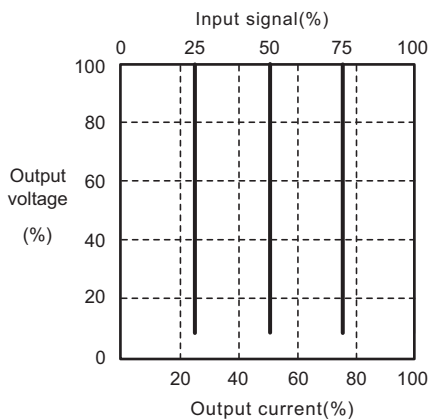
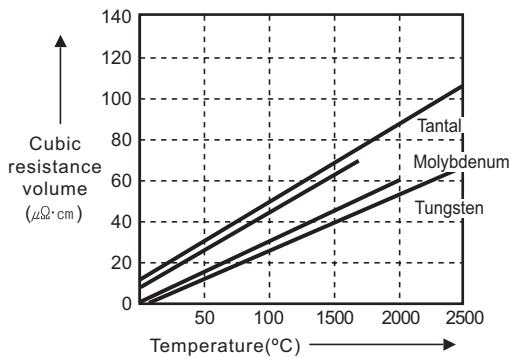

④ Static power Mode (Electric powr-Feedback) [P-Fb]

- If Load is SIC heating element, as load which generates resistance change by heat and resistance change by age change, it outputs regular power which is not affected by resistance load and in proportion to control input.

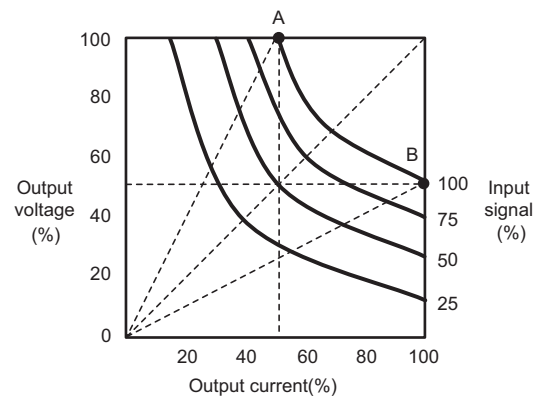
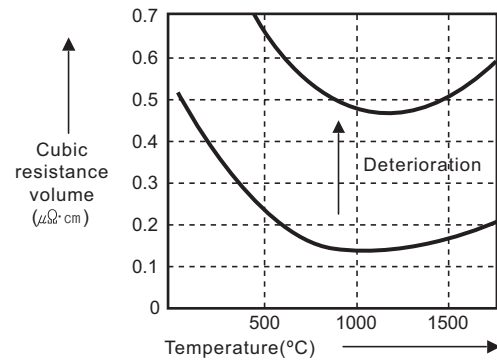

- Output feature is equivalent to 50% of output of connecting curve between the point(A) of [output voltage 100% x output current 50%] and the point(B) of [output voltage 50% x output current 100%], and current output capacity of this unit should be selected as twice of load capacity.

⑤ Fixed cycle control (Burst firing with fixed time base) [F-ϒ]

- It controls power supplied to load by reiterating ON/OFF cycle as below by regular ratio according to control input signal for regular cycle(60 cycles).

Ex.) Fixed cycle(60 cycles) control - when controlling output by 40%

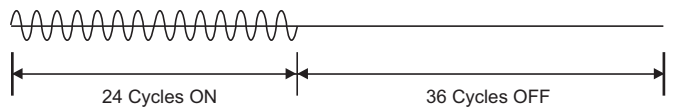

Ex.) Fixed cycle(60 cycles) control - when controlling output by 90%

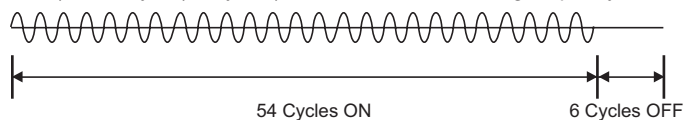

⑥ Variable cycle control (Burst firing with variable time base) [ν - CY]

- It controls requiring power depending on control input signal by using the number of minimum cycle of AC Sine wave and optimizes temperature change of objective control.

Ex.) Variable cycle control - when controlling output by 30%

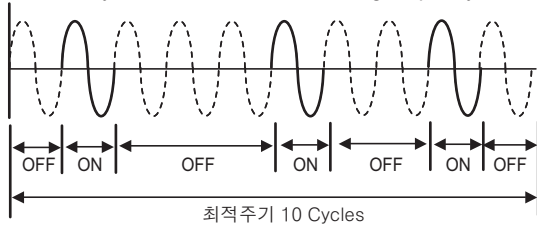

⑦ ON/OFF control type [ONOFF] - Zero-Cross Switching

- When control input is OFF, output is OFF(0%) / When control input is ON, output is ON(100%) (Same as SSR)

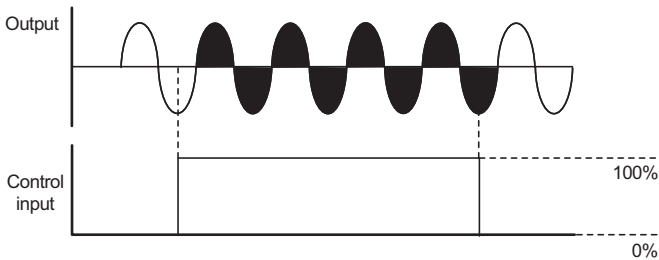

• SOFT START function [S_{L-T}]

- When supplying power, it sets time to protect load by output increased gradually within setting time. Controlling load with flowing inrush current(platinum, molybdenum, tungsten, infrared lamp, etc.) or control input is changed rapidly.
- SOFT START function is operating by Phase control regardless of control method(phase control, cycle control).
- SOFT START function is setting time which is reaching up to 0~100% of output.
- Setting range of SOFT START : 0 ~ 100sec (0sec : do not use SOFT START function).
- SOFT START function is operated as only following condition. : When operating as at STOP after POWER ON and RESET
- SOFT START function is not operated when objective output is 0% (control input is 0%).
- SOFT START function is terminated if reaching to objective output value.
- SOFT START setting time t means the time of till output supplied to load increased to 100% and time for reaching is $t/2$ in case of final objective output value 50%.
- Final objective output value reaching time = objective output(%) x t .

Ex) SOFT START time : 25 sec

Final objective output : 80

$$0.8 \times 25 = 20\text{sec}$$

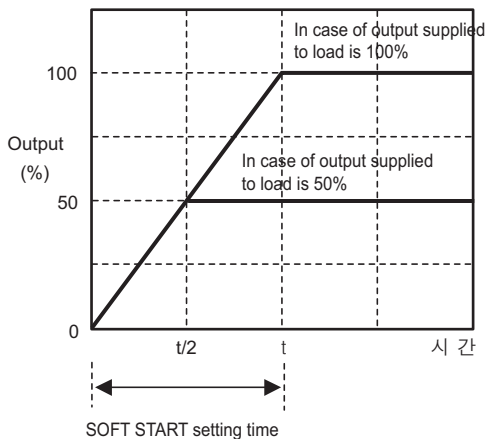

• Starting limit [$S_{-L\bar{n}}$] and time of Starting limit

[time of Starting limiter: $S_{-L\bar{n}}$]

- Starting limit function sets limit output and time protecting from inrush current when STOP is converted to RUN, alarm RESET after Power-on.
- Starting limit function is operating by Phase control regardless of control method(phase control, cycle control).
- Setting range of Starting limit : 0% ~ 100% of output
- Setting range of Starting limit time : 0 ~ 100sec (but, when setting as 0sec, starting limit is not used).

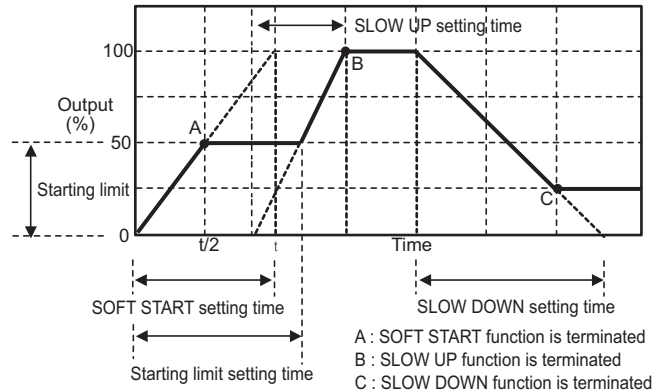

• Setting output slope function [OUTPUT SLOPE : $S_{L\text{OP}}$]

- This function is to set fluctuating ratio of output depending on control input in range of 0.00~1.00.
- When setting slope, output value is [input(%) X slope value].

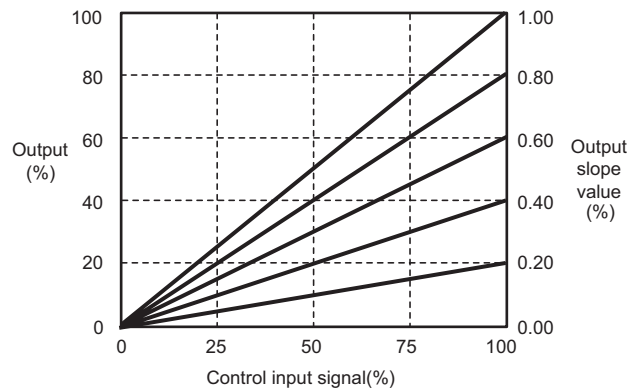

• BASE-UP function [Base-up setting : b_{-UP}]

- BASE-UP function is adding BASE
- UP setting value to input signal.
- The range of BASE-UP setting value is BASE-UP setting value < High output limit value.
- BASE-UP setting value is possible for setting when only output Low limit value is 0%. In case of output limit value is set to voluntary value, BASE-UP function parameter [B-UP] is not indicated.
- When initial operation, it is restricted by starting limit value.
- When setting BASE-UP, output is [input(%) X slope value + BASE-UP setting value].

A

Recorders

B

Data Loggers

C

Indicators

D

Converters

E

Controllers

F

Thyristor Units

G

Transmitters

H

Temp. Sensors

I

Thermo Meters

J

Pressure Gauges

K

Others

DPU series (1Phase)

DPU series (3Phase)

SPU

ZPU

LM-200/LP100

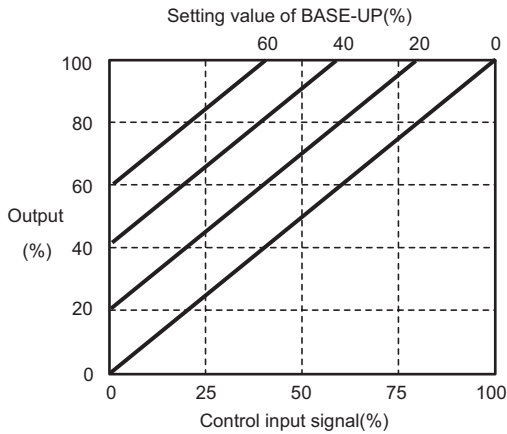

• SLOW UP / SLOW DOWN function [UP-t / dn-t]

- As this function has same purpose with SOFT START function, it is, when initial operation, operating once but SLOW UP / SLOW DOWN function is operating during RUN.
- SLOW UP / SLOW DOWN function is operating by Phase control regardless of control method(phase control, cycle control) as like SOFT START function.
- SLOW UP / SLOW DOWN function is terminated if reaching to objective output value.
- Setting range of SLOW UP / SLOW DOWN : 0 ~ 100sec (0sec : do not use SLOW UP / SLOW DOWN function).

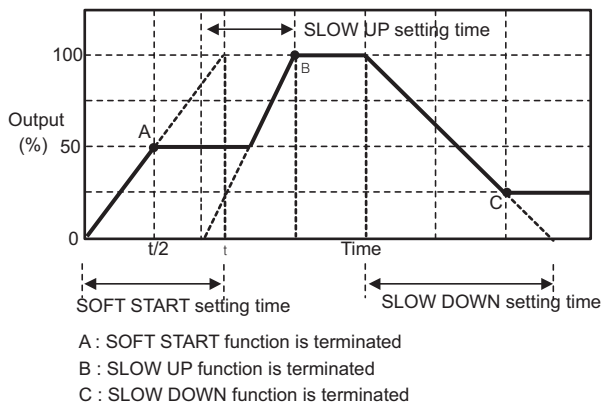

• High / Low output limit restricting function [High-output limit restricting value (HIGH-OUTPUT LIMIT : H-OL), Low-output limit restricting value(Low-OUTPUT LIMIT : L-OL)]

- High / Low output limit restricting function is for protecting load by restricting the range of output.
- Setting range : 0% Low-output limit restricting value < High-output limit restricting value 100%

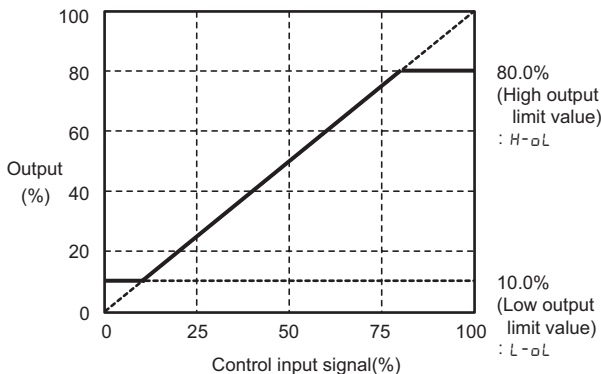

• DI (Digital Input) function

- It is possible for operating below functions by using terminal input.
- Digital input has the total of 5 terminals as Auto/Manual terminal, Run/Stop terminal, DI-1 ~ DI-3.
- DI-1 ~ DI-3 are able to select function for each input terminal.

① DIGITAL INPUT for selecting Auto/Manual [No.7 - 11 terminal]

- Select Auto(CLOSE) / Manual(OPEN) by terminal input.

- Auto Mode accepts analog input (voltage, current) and ON/OFF (including SSR pulse input) to control input and is controlled to output of instrument according to control input.

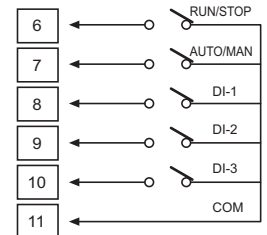

- Manual Mode accepts internal manual volume or external manual volume to control input and controlled to output of instrument according to control of manual volume.

- When Auto(CLOSE), front Auto lamp is turned on.
- When Manual(OPEN), Auto lamp is turned off.

② Conversion of Run / Stop DIGITAL INPUT (Terminal no. 6 - 11)

- Run(CLOSE) / Stop(OPEN) operation by terminal input
- Run Mode is that instrument is operated by control input as set contents and Stop Mode is that instrument is on standby.

- When Run(CLOSE), front Run lamp is turned on.
- When Stop(OPEN), Run lamp is turned off.

③ DI-1 ~ DI-3 (DIGITAL INPUT no.1~3) terminal [no.8, 9, 10 - 11(COM)terminal]

- For each DIGITAL INPUT, it could be set by using parameter (DI-1, DI-2, DI-3) and selecting function separately.

- When DI input is ON(CLOSE), front EVT lamp is turned on.
- When it is OFF(OPEN), EVT lamp is turned off.

- It can be selected 6 functions as follows

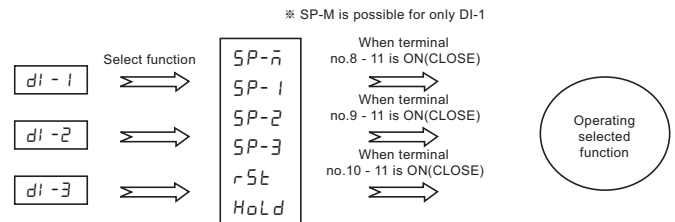

- RESET function [rst]

- After selecting RESET function and suitable Digital Input is ON(CLOSE) and if OFF, instrument will be reactivated after RESET.

- HOLD function [Hold]

- After selecting HOLD function and if suitable Digital Input is ON(CLOSE), output and indicating value of instrument will be held. (When Digital Input is stayed by ON(CLOSE) only, HOLD will be operated)

- Single SP function [SP-1, SP-2, SP-3]

- Single SP function designate SP-1, SP-2, SP-3 for each Digital Input and output is reaching to suitable SP.

It is possible for setting on each $d1-1$, $d1-2$, $d1-3$ and dual setting is possible as well and if $5P-1$ is designated, $5P1$ / if $5P-2$ is designated, $5P2$ / if $5P-3$ is designated, $5P3$ will be indicated on each Operating MODE.

Namely, if it is not designated, it will not indicate SP value setting parameter on Operating MODE.

Ex)

$d1-1$	$d1-2$	$d1-3$	Operating MODE SP value setting parameter
			$5P1$ (Ex:20%)
$5P-1$	$5P-2$	$5P-3$	$5P2$ (Ex:40%)
			$5P3$ (Ex:60%)

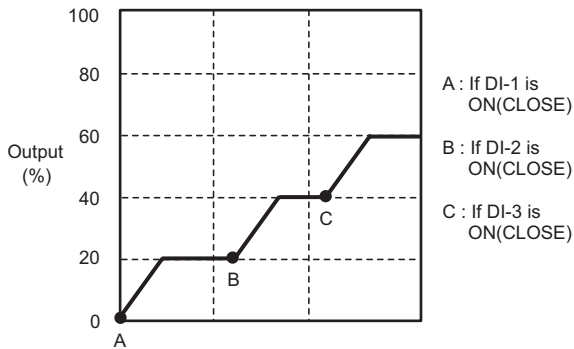

- Multi SP function [$5P-\bar{n}$]

- Multi SP function can set the amount of 6 SPs and control output according to the 3 Digital Input contents.

- Multi SP function can only be selected on DI-1 and if selecting SP-M in DI-1, DI-2 and DI-3 parameter are not indicated.

- If selecting SP-M on DI-1, 6 parameters which are able to set will be generated on Operating Mode.

($5P1, 5P2, 5P3, 5P4, 5P5, 5P6$)

Ex)

	DI-1	DI-2	DI-3	Operating MODE SP value setting parameter
A	O	X	X	$5P1$ (Ex:20%)
B	X	O	X	$5P2$ (Ex:40%)
C	O	O	X	$5P3$ (Ex:60%)
D	X	X	O	$5P4$ (Ex:80%)
E	O	X	O	$5P5$ (Ex:100%)
F	X	O	O	$5P6$ (Ex:0%)
G	O	O	O	

Output (%)

※O:CLOSE, X:OPEN

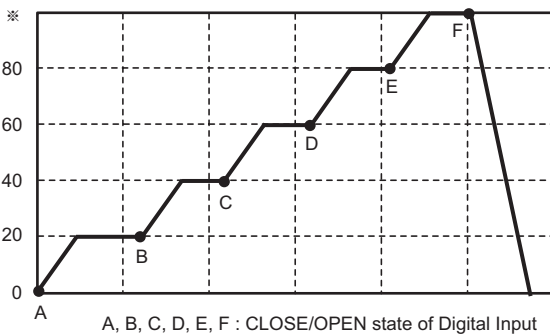

Set proportion and Integral constant of Feed Back control

- Proportional Integral Control : It is proportional control added to integral control. Proportional control accomplishes soft control without overshoot or hunting about setting value, and integral control is to reach stably to setting value by revising offset automatically.

- This instrument is set proportional constant and integral constant to optimum value when shipped. If user would like to change proportional constant and integral constant voluntarily and if using Feedback control, it will be possible for generating overshooting or hunting.

① Set proportional constant [P]

- It compensates tolerance for objective value proportionally.

- Setting range : 0(0%) ~ 2000(100%)

- Overshooting or hunting will be generated if setting small proportional constant value, and if setting large proportional constant value, the response will be slow.

② Set integral constant [I]

- It compensates accumulated tolerance for objective value proportionally.

- Integral constant set as time is the same time both proportional volume and integral volume.

- Setting range : 0.1 ~ 999.9 sec

- Overshooting or hunting will be generated if setting small integral constant value, and if setting large integral constant value, the response will be slow.

※ Above P, I parameter is indicated only if control mode controls Feed Back control.

Input compensation[INPUT BIAS : $IN-b$]

- Input compensation function is compensating OFFSET of both actual input value and measured input value.

- Input compensation setting range : -99.9% ~ 99.9%

Ex) If the type of input is 4~20mA

: When 4mA is authorized, if input monitor value indicates 0.5%, input monitor value will be 0.0% if set by $IN-b=-0.5$

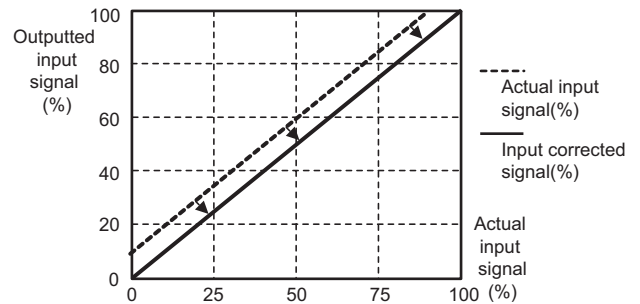

Correction of Input slope [$SPAN : 5PRn$]

- It corrects Gain for measured 100% input about actual 100% input value.

- Setting range of input slope correction : -99.9% ~ 99.9%

Ex) If the type of input is 4~20mA

: When 20mA is authorized, if input monitor value indicates 99.5%, input monitor value will be 100.0% if set by $IN-B=0.5$

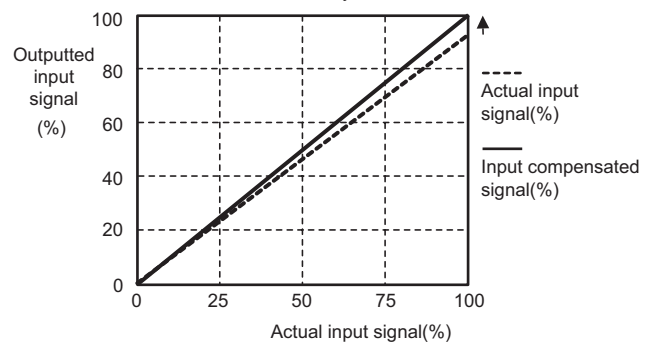

A

Recorders

B

Data Loggers

C

Indicators

D

Converters

E

Controllers

F

Thyristor Units

G

Transmitters

H

Temp. Sensors

I

Thermo Meters

J

Pressure Gauges

K

Others

DPU series (1Phase)

DPU series (3Phase)

SPU

ZPU

LM-200/LP100

• **Display selected contents [Display selected contents : $dI5P$]**

- Can set indicating value contents of display on operating mode.
- Selected possible indicating contents : load voltage[$Ld-U$], load current[$Ld-R$], power[P], control input[rEF]

• **BAR GRAPH's display selected contents**

[Bar graph's content : bAr]

- Able to select contents which BAR GRAPH indicates.
- Selected possible indicating contents : load voltage[$Ld-U$], load current[$Ld-R$], power[P], control input[rEF]

• **Selecting load resistance indicated direction function[$drE5$]**

- When monitoring load resistance value on Monitoring Mode, this function is to select indicating by increased direction or decreased direction for load resistance value be monitoring.

※ Refer to 9-24. Heater disconnected alarm.

• **Automatic recognized full load function [$F-Ld$]**

- This function is to recognize 0~100% about connected load.
- If press M key after selecting on at Setting Mode 1 group, load automatic recognition will be operated.
- In need of regular performance according to the change of passing year of load.

※ When automatic recognition, it is operating by 100% output for approx. 3sec.

• **Lock parameter function [LdL]**

- This function is to restrict check and change for setting value of parameter.

	OFF	$LdL1$	$LdL2$	$LdL3$
Operating Mode Setting group	●	●	●	○
Setting Mode 2 Setting group	●	●	○	○
Setting Mode 1 Setting group	●	○	○	○

●:Possible for check and setting,

○:Possible for check / Impossible for setting,

○: Impossible for check

- Lock parameter function is to be set by entering into Setting MODE 1 group but if selecting $LdL2$ or $LdL3$ on Lock function parameter and entering into Setting MODE 1 group, it will indicate Lock function parameter only.

• **Over current generation and alarm**

① Set over current alarm value[$OC-U$]

- It sets over current alarm value in the range of 0.0~120.0% of rated current.

② Over current alarm delayed time[$OC-t$]

- After reaching to over current alarm value by setting time in the range of 0~100 sec and passing delayed time, over current alarm will be operated.

③ When over current alarm is on, the condition of instrument

- If over current alarm is on, output will be STOP and alarm will be stayed.
- OC turns off at 0.5 sec intervals on display and EVT lamp turns off at 0.5 sec intervals.
- If alarm output designation is NON, OC turns off on display even if alarm output is not generated.

④ Alarm off

- Alarm off method is converted to reapplying the electric current, RESET, STOP of power.

⑤ Over current alarm output recognized parameter

: $OC-R$ (Initial value : $RL1$)

- This function is to recognize 0~100% about connected load.

• **Current limit[$C-Ln$]**

① Current limit function (When controlling static voltage)

- Current limit function is to protect thyristor by controlling current when inrush current is using large load and especially in case of voltage feed back, because current is flowed for resistance value of load and rated current of thyristor is not over by only voltage control, it can prevent over rated current by restricting current.
- Current limit setting range : 0% ~ 110% of rated current

② Current alarm (When controlling the exception of static voltage) If current reaches setting current limit value, designated alarm will be on.

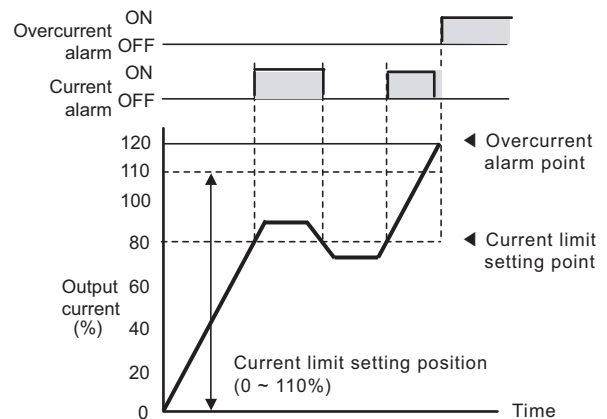

• **Current alarm**

① Current alarm is on

- If reaching to current restricted setting value, alarm will be on.
- ② When generating over current alarm, the condition of instrument
- Even if current alarm is on, control operation will be stayed.
- Both $C-RL$ and indicating value turn off at 2 sec intervals on display and EVT lamp turns off at 0.5 sec intervals.
- If alarm designation is NON, $C-RL$ turns off on display even if alarm output is not generated.

③ Alarm off : If current is under current restricted setting value, alarm will be off.

④ Current alarm output designating parameter :

$C-RL$ (Default value : $RL2$)

• **Over Voltage generate and alarm**

① Set over voltage alarm value [$OV-U$]

- It sets over voltage alarm value in the range of 0.0~120.0% of rated current.

② Over voltage alarm delayed time[$OV-t$]

- After reaching to over voltage alarm value by setting time in the range of 0~100 sec and passing delayed time, over voltage alarm will be operated.

③ When over voltage alarm is on, the condition of instrument

- If over voltage alarm is on, output will be STOP and alarm will be stayed.
- OV turns off at 0.5 sec intervals on display and EVT lamp turns off at 0.5 sec intervals.
- If alarm output designation is NON, O-U turns off on display even if alarm output is not generated.

• Current limit[$\bar{C-L}$]

- ① Current limit function (When controlling static voltage)
 - Current limit function is to protect thyristor by controlling current when inrush current is using large load and especially in case of voltage feed back, because current is flowed for resistance value of load and rated current of thyristor is not over by only voltage control, it can prevent over rated current by restricting current.
 - Current limit setting range : 0% ~ 110% of rated current
- ② Current alarm (When controlling the exception of static voltage)If current reaches setting current limit value, designated alarm will be on.

• Abnormal of element(Thyristor) and alarm

- ① Element(Thyristor) abnormal alarm is on
 - Even if output is 0%, 10% or more of rated current is continuously flowing for over 3sec(or over 5cycle), element(Thyristor) abnormal alarm will be on.
- ② When element(Thyristor) abnormal alarm is on, the condition of instrument
 - If element(Thyristor) abnormal alarm is on, output will be STOP Mode and alarm will be stayed.
 - \bar{SCL} turns off at 0.5 sec intervals on display and EVT lamp turns off at 0.5 sec intervals.
 - If alarm output designation is NON, \bar{SCL} turns off on display even if alarm output is not generated.
- ③ Alarm off
 - Alarm off method is converted to reapplying the electric current, RESET, STOP Mode of power.
- ④ Element(Thyristor) abnormal alarm output designating parameter : \bar{SCL} (Default value : RL 1)

• Burn-out heater (load resistance) alarm

- ① Burn-out heater alarm is on.
 - When load resistance automatically recognize Full load, if setting value is staying less than connected load resistance(When setting load resistance indicating direction DOWN) for 30 sec, burn-out heater alarm will be on.
 - When load resistance indicating direction is set to UP and more than setting value, alarm will be on.
 - Control method is operating by Phase control regardless of control method(Phase control, Zero crossing control)
 - For suitable operation, it needs load current of control output(phase control or cycle control) of 10% and rated current over 30%.
- ② Burn-out heater alarm setting parameter(HB-V)
 - Setting range : 10 ~ 500%
- ③ When burn-out heater alarm is on, the condition of instrument.
 - Even if burn-out heater alarm is on, control operation will be stayed.
 - H-BY turns off at 2 sec intervals on display and EVT lamp turns off at 0.5 sec intervals.
 - If alarm output designation is NON, H-BY turns off on display even if alarm output is not generated.
- ④ Burn-out heater alarm hysteresis.
 - When burn-out heater alarm is on, the interval of ON/OFF will be fixed to 1%.

Ex) When burn-out heater alarm setting value is 50%, the point of alarm ON:50%, the point of alarm OFF:49%.

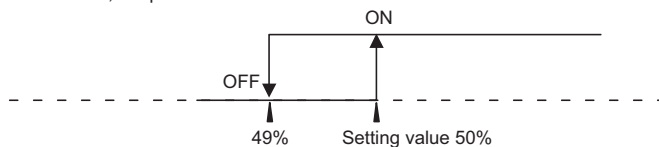

⑤ Alarm OFF

- If it is less than burn-out heater setting value, alarm will be automatically off.

⑥ Burn-out heater alarm output designating parameter :

$Hb-R$ (Initial value : RL 2)

• Summary of the type of alarm

Type of alarm	Display	When alarm on, operation of instrument	Alarm off
Over current	$\sigma-C$	Output STOP (SCR OFF)	<ul style="list-style-type: none"> • Reapplying an electric power • RESET(RET KEY) • Conversion to STOP Mode
Over voltage	$\sigma-u$		
Burn-out fuse	FUSE ^{*1}		
Heat sink over temperature	$\bar{tE}\bar{n}P$		
Abnormal element	\bar{SCL} ^{*1}	Operation is stayed	When returning, automatic off in setting range
Current alarm	$\bar{C-RL}$		
Burn-out heater alarm	H-b \bar{t}		

* When burn-out and abnormal element, if alarm off is not possible by reapplying of electric power, refer to[10.Maintenance].

A

Recorders

B

Data Loggers

C

Indicators

D

Converters

E

Controllers

F

Thyristor Units

G

Transmitters

H

Temp. Sensors

I

Thermo Meters

J

Pressure Gauges

K

Others

DPU series (1Phase)

DPU series (3Phase)

SPU

ZPU

LM-200/LP100

Digital Power Thyristor Unit
KONICS