

CSP-9A

Unit: mm

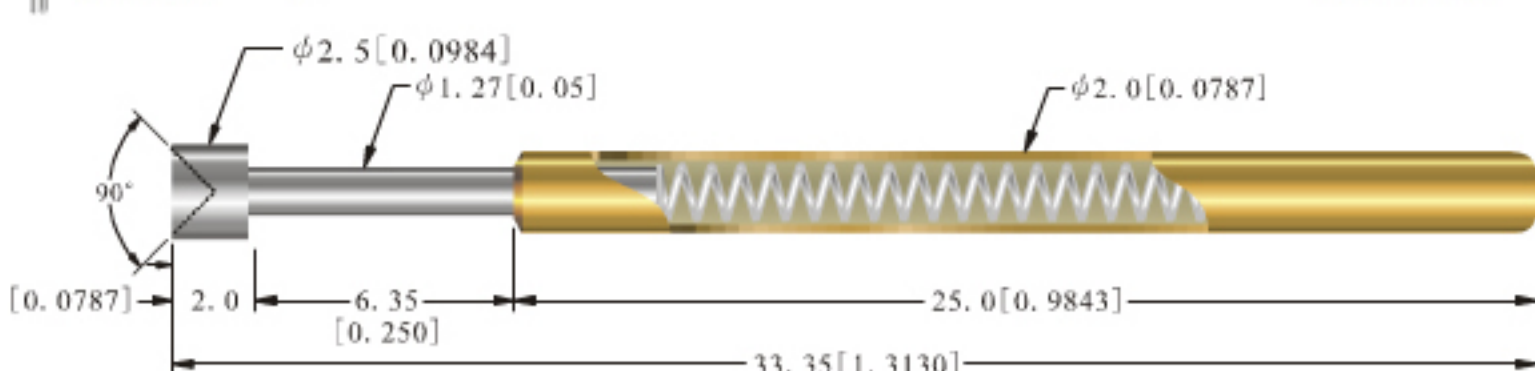

CSP-9B

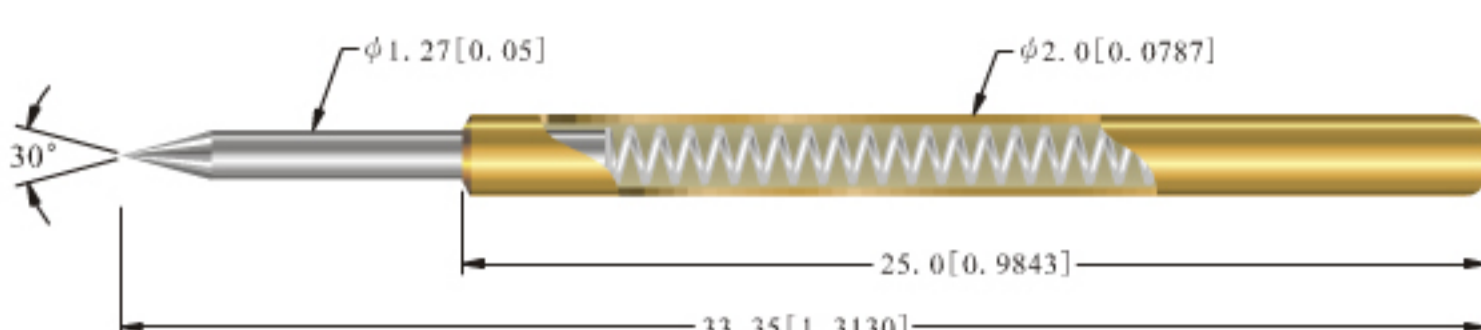

CSP-9F

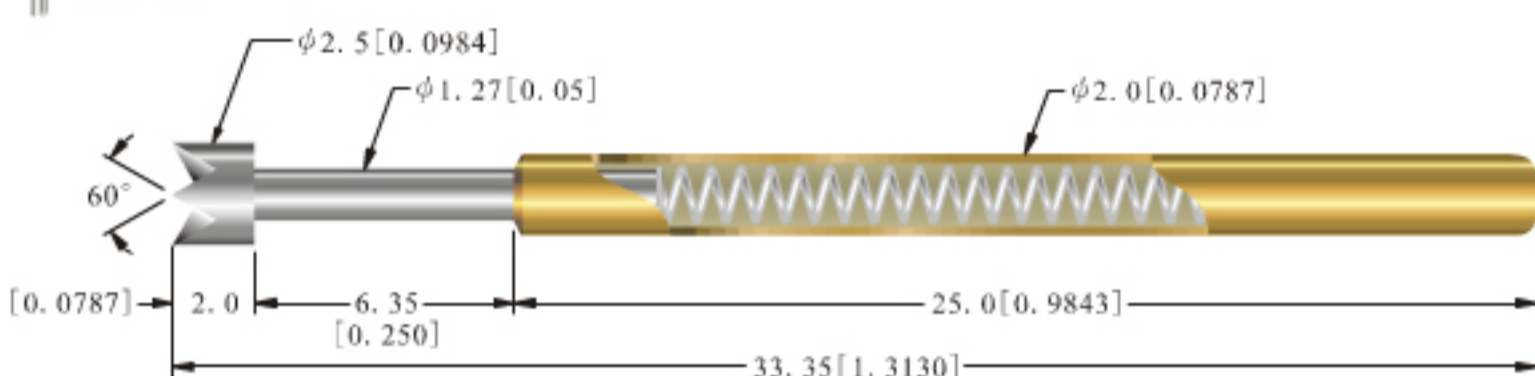

CSP-9H

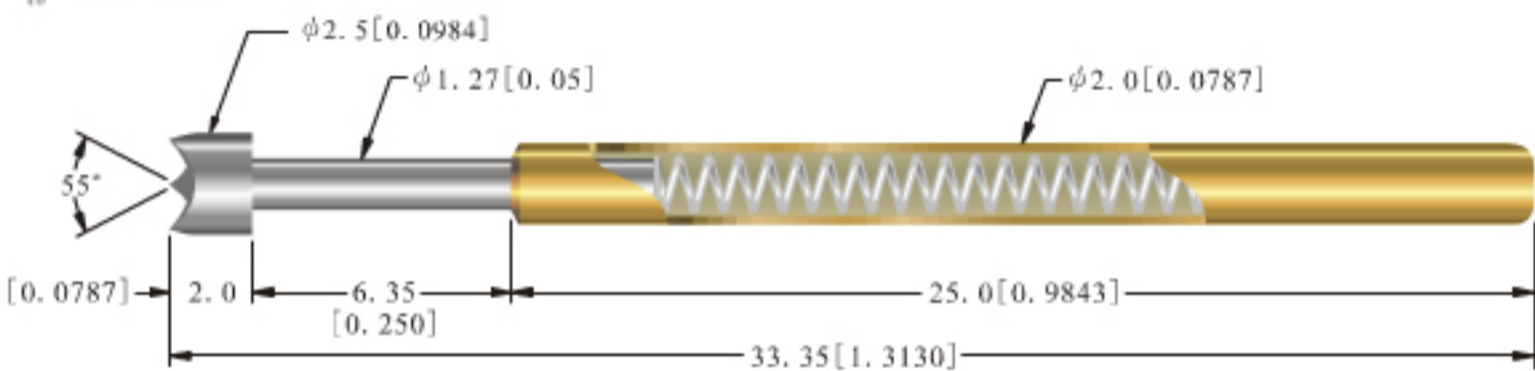

CSR-9VC

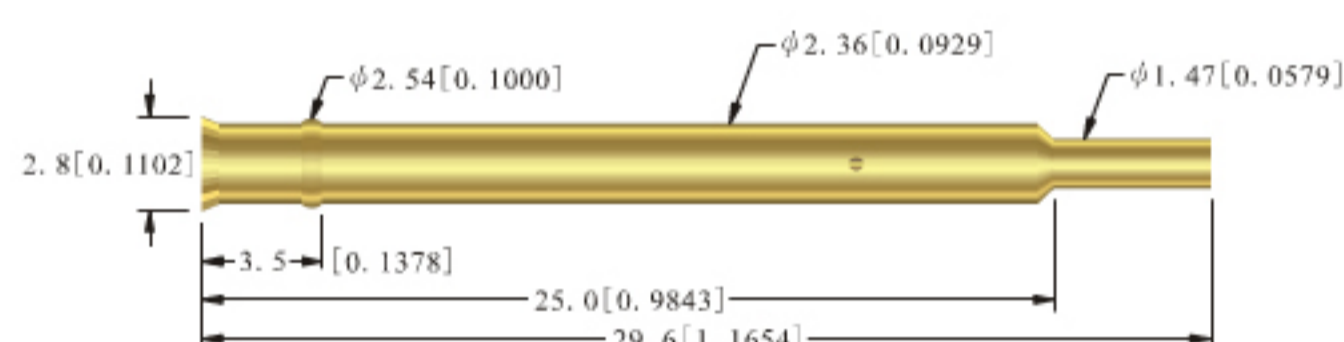

CSR-9V-1

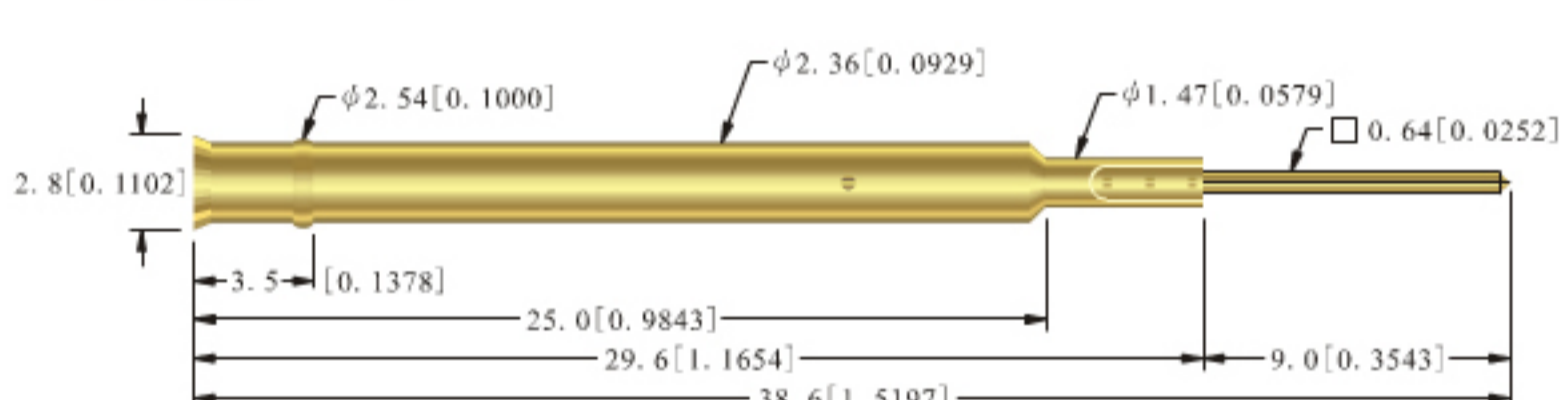

CSR-9WC

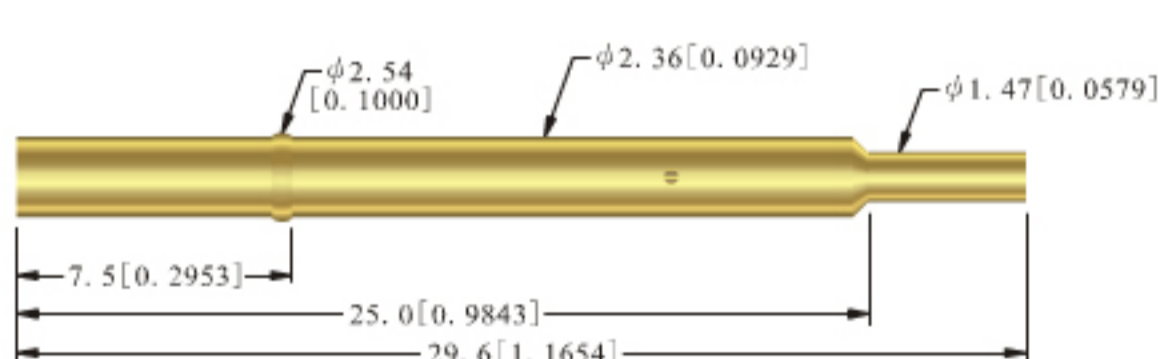

CSR-9W-1

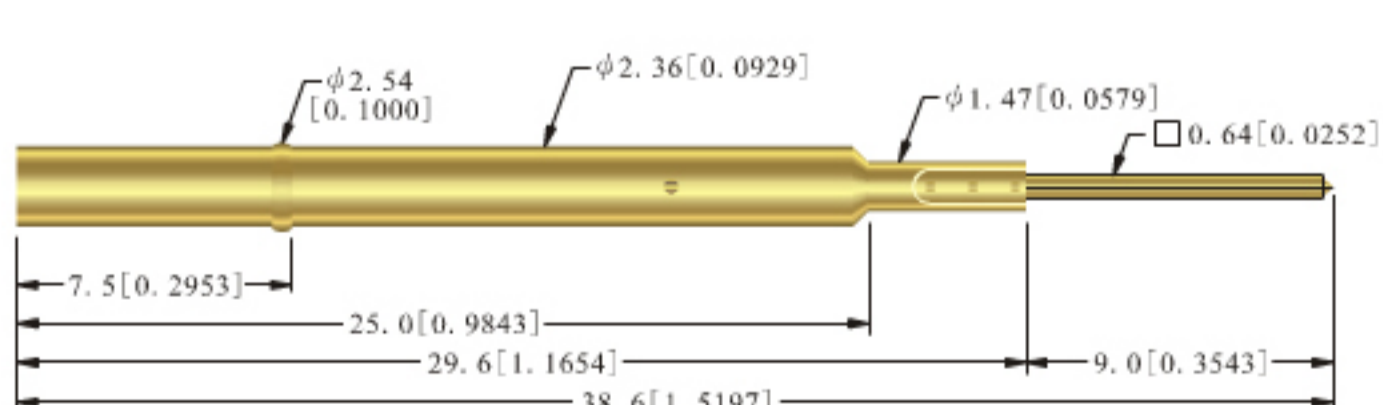

Plunger: Beryllium Copper with Rhodium Plated or Gold Plated

Spring: Stainless Steel

Barrel: Brass with Gold Plated

Receptacle: Brass with Gold Plated

Min. Center:	3.17 mm [0.1248 inch]	Current Rating:	5 A
Full Stroke:	6.35 mm [0.2500 inch]	Contact Resistance:	30 m Ω
Full Stroke Spring Force ($\pm 20\%$):	150 g [5.29oz]	Recommended Hole Size:	2.40mm-2.45mm [0.0945 inch]-[0.0965 inch]
2/3 Stroke Spring Force ($\pm 20\%$):	100 g [3.53oz]		