

Isolated converter CN-6000 series are able to make a variety of selections by users and set with self-diagnosis and special function using a high accuracy A/D converter and micro-process.

Features

- Clearer display by adopting 3-color LED
- Multi input (TC/RTD/mV/mA)
- Excellent display by adoption of negative LCD (Selection of 3 different colors)
- Indicating output scale by bar graph
- Indicating the type of input signal and unit conversion
- A wide variety of output type (Current, Voltage, Alarm)
- Isolated independent AO(Analog output) for channel 1&2 (0~10V, 0~20mA)
- Input and output scale setting function
- Input offset and slope compensation function
- Peak hold function
- Internal sensor power supply (24VDC)

Ordering Codes

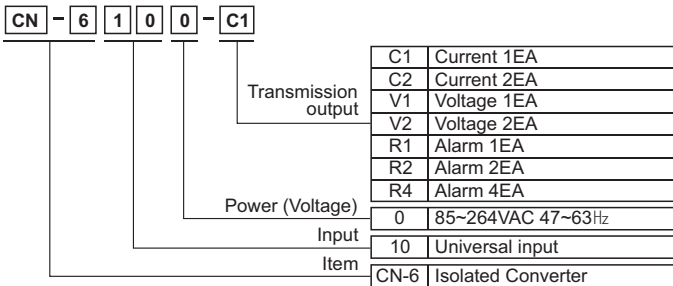

Connections

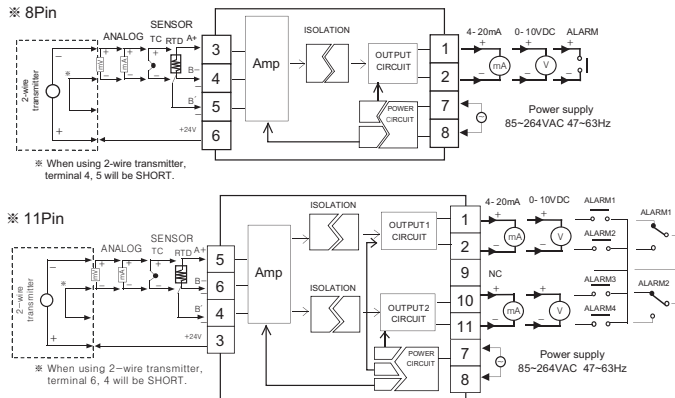

Specifications

Model	CN-6100 Series	
Power supply	85 ~ 264VAC 47 ~ 63Hz	
Power consumption	Approx. 8VA (264VAC 60Hz)	
Display	12 Segment, 4 low LCD display (Conversion of RED, GREEN, YELLOW colors) Graphic bar & Input / Unit display (RED)	
Character size	W:6.4mm×H:11.0mm(12 Segment) / W:1.4mm×H:2.75mm(Unit)	
Output	Current	0 ~ 20mA (Controlling the range of output), Load resistance Max.600Ω
	Voltage	0 ~ 10VDC (Controlling the range of output), Load resistance Min.10KΩ
	Alarm	1 point : Relay contacting point capacity 250VAC 1A 1a 2 point : Relay contacting point capacity 250VAC 3A 1a 4 point : Relay contacting point capacity 250VAC 1A 1a
Indicating accuracy	±0.2% F · S ±1Digit(25±5?), ±0.3% F · S ±1Digit(-10~20 °C, 30~50 °C) ※ But, Under - 100 °C in TC, ±0.4% F.S ±1Digit ※ TC-T, TC-U are at Min.±2.0 °C	
Setting method	Set by Key	
Input sampling cycle	100ms (Analog input), 250ms (Temperature input)	
Function	Alarm, Peak-hold, Digital input(Front key), Lock, Input special unit, Input scale, User compensation, Display scale, Output range, Input scale, Input & Output upper/lower expansion, Digital filter, Changing color for display / switching, Burn out	
Internal voltage	2000VAC 50/60Hz during a minute (Between input terminal and power terminal)	
Internal vibration	0.75mm Amplitude at frequency of 5~55Hz in each of X, Y, Z directions for 2 hours	
Isolation resistance	Over 100MΩ (500VDC Mega STD.)	
Internal noise	±2KV the square wave noise (pulse width : 1μs) by the noise simulator	
Memory retention	About 10 years (when using non-volatile memory semiconductor)	
Using ambient temperature	-10 °C ~ 50 °C (at non-freezing status)	
Storage temperature	-20 °C ~ 60 °C (at non-freezing status)	
Using ambient humidity	35 ~ 85% RH	
Weight	Approx. 200g (except for packing box)	

Dimensions, Panel Cutout

(Unit : mm)

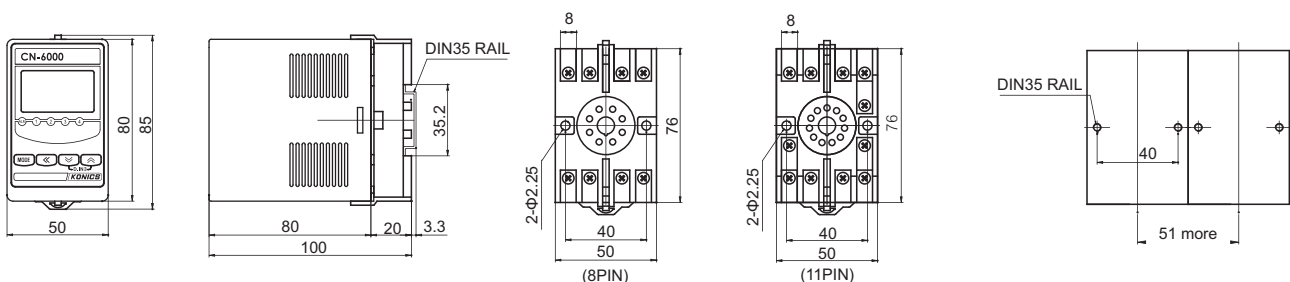

Functions

• Unit conversion function (Program mode : Uni E)

In case of temperature input, it can be set to °F or °C. When it changes Unit, all Prescale, Alarm, Output scale, etc. are initialized. Therefore, user needs to reset it in accord with the purpose.

* Formula : °F = 1.8 °C + 32

• Digital input function (Program mode : di -E)

It is able to operated through input terminal as below 3 kinds of function.

Mode	Operation
Alarm ON/OFF function $ALrE$	Although alarm is off, when setting Alarm ON/OFF function, alarm is unable to off. Then, using function by compulsive alarm off.
Hold indicated value function $Hold$	Temporarily indicated value is stopped in order to confirm indicated value, in flexible input
Zero adjustment function $Zero$	"Ⓢ Same as Input compensation function."When zero adjustment, compensation value is possible to confirm and change in $In-C$

• Input compensation function (Program mode : IN-B)

It has not any errors by itself but, if temperature input, analog input etc. occur regular error, this function can add and subtract compensation value for measurement value. Only in case of $InSF = EUF$, $In-b$ is operated with atmospheric pressure input value instead of input compensation function. (Refer to "• EUF function")

Ex) In case sensor temperature is 4 °C and actual temperature is 0 °C, PV indicates 0 °C if setting $In-b = -4$.

• Expansion and control the upper/lower limit deviation of input and transmission output function (Program mode : EAJ O)

This function is to adjust the range of analog input/output. Please use after setting in accord with environment, because it can be changed with input/output to the point you want, if set as below. Following a diagram is the output range of 4-20mA

Mode	Operation
OP	Output 4-20mA in only the output range of 4-20mA
$5P$	Output 3.2-20.8mA to the input range which is out of 5% of 4-20mA output range
$10P$	Output 2.4-21.6mA to the input range which is out of 10% of 4-20mA output range

• Indicating scale function (Program mode : H-SC, L-SC)

Regarding voltage and current input, this function voluntarily sets upper / lower limit indicating scale.

As below diagram, if analog input is a, b and voluntary indicating value is A, B for a, b input, a->A, b->B are indicated.

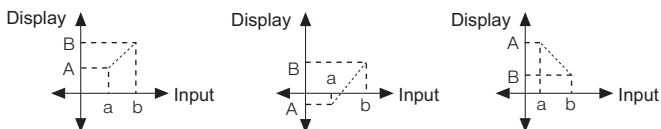

• Indicating front alarm lamp function

When alarm is operated for relevant channel, as this function is to indicate the condition through alarm lamp, it is easily visible about the alarm condition by bar graph of relevant channel is flickering or lighting.

• Input special function (Program mode : InSF)

This function is used for when input value and PV are through calculation of Square, Root(√) or TUF in case of voltage, current input.

Message	Lin	root	Sqr	EUF
Function	Input value without any operation	Input value with	Input value with x2	
Graph				Refer to Two unit function
Application	General Measurement Input requiring linearization	Measure flow with Orifice	When differential output is from flow signal	

In Sqr - message, PV and mA output value is : PV (output value) = $\left(\frac{\text{Input value} - L.rnG}{H.rnG - L.rnG}\right)^2 \times (H-SC - L-SC) + L-SC$

In $root$ message, PV and mA output value is : PV (output value) = $\left(\sqrt{\frac{\text{Input value} - L.rnG}{H.rnG - L.rnG}} \times (H-SC - L-SC) + L-SC$

Two unit function
- If ductile pressure is lower than air pressure(0), this is indicating the degree of vibration of mmHg, but if ductile pressure is same or higher than air pressure, this is indicating the static pressure of kg/cm² unit.

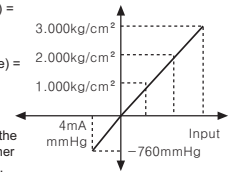

• Alarm function (AL - 1, AL - 2, AL - 3, AL - 4)

- This indicator has 4 alarm(2 alarm) and can set alarm operation separately.
- If it does not have alarm output, it does not have alarm function.
- Alarm operation is operating through mixing 'alarm type' and 'alarm option'
- Alarm type and option can set on program mode and alarm value (AL - 1, AL - 2, AL - 3, AL - 4) can set on monitoring mode.
- How to check parameter

Alarm option	Alarm type
A:Normal alarm b:keeping alarm c:Expectation alarm d:keeping alarm + Expectation alarm	0:Not use alarm function 1:Upper limit alarm 2:Lower limit alarm 5bA:Disconnected sensor alarm

① Alarm type

Alarm type	Explanation for alarm operation
Not use alarm output	- Eventhough it has alarm output inside and set to 'Not use alarm output', alarm output is not operated - 'Not use alarm output' has not alarm option
Upper limit alarm	PV ≥ 800 °C Alarm output ON Upper limit alarm value is set on AL - 1, AL - 2, AL - 3, AL - 4 of monitoring mode.
Lower limit alarm	PV ≤ 200 °C Alarm output ON Lower limit alarm value is set on AL - 1, AL - 2, AL - 3, AL - 4 of monitoring mode.
Disconnected sensor alarm	- In case disconnecting sensor and alarm output is ON, output is stable continuously. - 'Disconnected sensor alarm' does not have alarm option. * Keeping alarm can be removed by using 'Digital Input function' or power off

② Alarm option

Alarm option	Explanation for alarm operation
Normal alarm	- If it reaches alarm temperature, alarm output is ON but, if it is out of range, output is OFF
keeping alarm	- If it reaches alarm temperature, alarm output is ON and condition is stable continuously. (Alarm output HOLD) * Keeping alarm can be removed by using 'Digital Input function' or power off.
Expectation alarm	- If it reaches alarm temperature at first time, alarm output is not ON but, since second time, if it reaches alarm temperature, normal alarm is operating.
keeping alarm+ Expectation alarm	- keeping alarm and expectation alarm are operating at once.

• Save peak value function

This function is to check when the abnormal condition of system for input, saving Max. value and Min. Value. It is possible to check by entering the first setting group on RUN mode.

When Max. value and Min. value are out of the range of pressure, indicating HHHH, LLLL

It can be initialized by using \square , \square key, when display Max. Peak value (HPEE) or Min. Peak value (LPEE)

then peak value is initialized to current input value.

• Error indicating function

This has error monitoring function inside. If it occurs error as below diagram, please check input or setting condition and should take action correctly.

Display	Description	Action
LLLL	When measured sensor input is lower than indicating	Input should be within indicating range.
HHHH	When measured sensor input is higher than indicating	-
bURN	When temperature sensor is disconnected	Check the condition of temperature sensor.
ERR	If there is error under operation.	After checking the setting condition, reset.
ERR I	If input setting and position of switch is inconsistent (but, temperature sensor and analog input are classified)	After checking input specification, reset.

• Initializing parameter function (Program mode : i n i t)

After pressing [MODE] key + [↵] key for 3 sec simultaneously and indicating [i n i t] on display, if press [MODE] key by using [↓] or [↑] key when it indicates [YES], it process initializing.

(※ Parameter initialization is possible only when [LoLl] function is OFF.)

• Transmission output scale function (HOUT, LOUt), Transmission output range function (HORP, LORP)

This function is to set output for indicating value on analog output. When indicating HOUT, it outputs analog output value setting to that output 1 is HOR 1 / output 2 is HOR 2 and when indicating LOUt, it outputs analog output value setting to LOR 9. 1/20

※ OUTPUT ACCURACY = OUTPUT SCALE / FULL SCALE

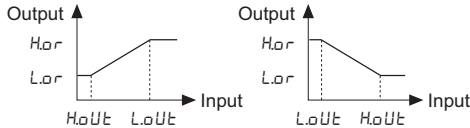

• Digital filtering function (Program mode :

AVF MARF - User lever : HIGH)

Normal average filter [AVF] is the indicating type by averaging the N cycle of sampling value. Moving average filter [MARF] indicates in real-time by averaging the previous N cycle of sampling value.

※ Setting range : 0 132 (If setting 01, it does not operate digital filtering function)

• Display color changing and switching function

(Program mode : CoLR)

This function is to select the color of front display among red, green, yellow.

Parameter	Explanation
REd	Display color is RED.
GRN	Display color is GREEN (Factory defaults).
YELo	Display color is YELLOW.
R--G	When EVENT? is operated, display color is to GREEN from RED.
G--R	When EVENT? is operated, display color is to RED from GREEN.

※ EVENT : When alarm is on and when it indicates HHHH, LLLL, BURN, ERR.

• Burn out function (Program mode : bURN)

When TC temperature sensor is disconnected, this function is transmitting the abnormal accident and outputting the value of HHHH or LLLL condition according to the setting and display is flickering [bURN] message.

- If setting BURN=ON, it outputs 20mA/10V/HIGH-ALARM.

- If setting BURN=OFF, it outputs 4mA/0V/LOW-ALARM.

(※ When analog output, the setting maximum / minimum value outputs to input/output expansion function)

• Lock mode (Program mode : LoLl)

This function is to check setting value of parameter and to restrict changes.

	oFF	LoLl 1	LoLl 2
First setting group	●	◐	○
Second setting group	●	●	◐

- Check/setting possible
- ◐ Check possible/setting impossible
- Check impossible

※ If lock mode is set to LoLl 2 and enter into program mode, it is only indicating LoLl parameter.

Front Panel Identifications

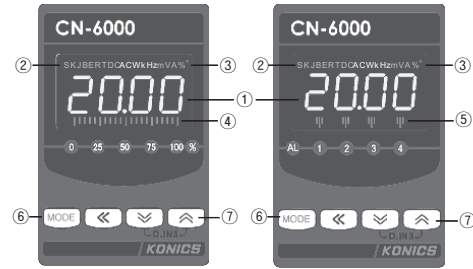

- ① Indicating display : When operating, it displays present value / When setting parameter, it displays parameter and set value.
- ② Input specification display : Input type at IN-P parameter is flickering. (If selecting TC sensor, TC-L, TC-N, TC-U, TC-P, it displays at the right side)
- ③ Indicating unit
- ④ Output scale BAR : In case of analog output, output displays to % by scale BAR.
- ⑤ Alarm output lamp : When alarm output, the alarm lamp is flickering.
- ⑥ MODE key : It is used for when entering to setting mode or when moving between parameters.
- ⑦ Moving key, UP / DOWN key : It is used for that setting parameter.

Input Range for the Sensors

Sensor	Type	Display	Using(display) temp. range °C	Using(display) temp. range °F
Thermo couple	K(CA)	Tck1	-200 ~ 1350	-328 ~ 2462
	K(CA)	Tck2	-199.9 ~ 999.9	-328 ~ 1832
	J(IC)	TC-J	-199.9 ~ 800.0	-328 ~ 1472
	E(CR)	TC-E	-199.9 ~ 800.0	-328 ~ 1472
	T(CC)	TC-T	-199.9 ~ 400.0	-199.9 ~ 752.0
	B(PR)	TC-B	400 ~ 1800	752 ~ 3272
	R(PR)	TC-R	0 ~ 1750	32 ~ 3182
	S(PR)	TC-S	0 ~ 1750	32 ~ 3182
	N(NN)	TC-N	-200 ~ 1300	-328 ~ 2372
	C(W5)	TC-C	0 ~ 2300	32 ~ 4172
	L(IC)	TC-L	-199.9 ~ 900.0	-328 ~ 1652
	U(CC)	TC-U	-199.9 ~ 400.0	-199.9 ~ 752.0
	Platine II	TC-P	0 ~ 1390	32 ~ 2534
RTD	CU50Ω	Cu50	-199.9 ~ 200.0	-199.9 ~ 392.0
	CU100Ω	Cu10	-199.9 ~ 200.0	-199.9 ~ 392.0
	JPt100Ω	JPt1	-199.9 ~ 600.0	-328 ~ 1112
	DPt50Ω	DPt5	-199.9 ~ 600.0	-328 ~ 1112
	DPt100Ω	DPt1	-199.9 ~ 850.0	-328 ~ 1530
Analog	Current	0.00 ~ 20.00mA	aMA1	Scale display range : -1999 ~ 9999
		4.00 ~ 20.00mA	aMA2	
	Voltage	-50.0 ~ 50.0mV	aMV1	
		-199.9 ~ 200.0mV	aMV2	
		-1.000 ~ 1.000V	A-V1	
		-1.00 ~ 10.00V	A-V2	

• If applying an electric current with pressing M key simultaneously, the type of input is able to be expanded.