





## 6 - Zelio Logic smart relays and Zelio Analog analogue interfaces

---

### Zelio Logic smart relays

*Selection guide* ..... page 6/2

- Compact smart relays ..... page 6/14
- Modular smart relays ..... page 6/15
- Separate components for compact and modular smart relays ..... page 6/16

### Zelio Analog - analogue interfaces

- Converters for thermocouples and Pt100 probes ..... page 6/24
- Voltage/current converters ..... page 6/24

# Zelio Logic smart relays

Compact and modular smart relays

Smart relay type	Compact smart relays				
Number of I/O	10		12		20
Number of discrete inputs (of which analogue inputs)	6 (0)		8 (4)		12 (2)
Number of "relay" or "transistor" outputs	4		4		8
Supply voltage	= 24 V, ~ 100...240 V		= 12 V, = 24 V, ~ 24 V, ~ 100...240 V		
I/O extensions	No				
Modbus communication module ▲	No				
Clock	No		Yes		Depends on model
Display and programming buttons	Depends on model				
Programming language LADDER / FBD	LADDER		LADDER / FBD (1)		LADDER / FBD (1)
References	SR2 ●101●●		SR2 ●121●●		SR2 B122BD
Pages	6/14		6/14		6/14



6

(1) FBD: Function Block Diagram  
 ▲ Available: 1<sup>st</sup> quarter 2004.

**Modular smart relays**



10	26
6 (4)	16 (6)
4	10
= 24 V, ~ 24 V, ~ 100...240 V	
Yes (6, 10 or 14 I/O)	
Yes	
Yes	
Yes	
LADDER / FBD (1)	
SR3 B10●●●	SR3 B26●●●
6/15	6/15

(1) FBD: Function Block Diagram

# Zelio Logic smart relays

## Compact and modular smart relays

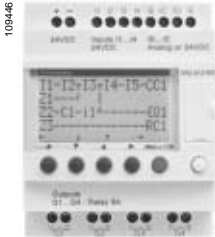

SR2 B121BD

### Presentation

Zelio Logic smart relays are designed for use in small automated systems. They are used in both industrial and commercial applications.

■ **For industry:**

- automation of small finishing, production, assembly or packaging machines.
- decentralised automation of ancillary equipment of large and medium-sized machines in the textile, plastics and materials processing sectors,
- automated systems for agricultural machinery (irrigation, pumping, greenhouses, ...).

■ **For the commercial/building sectors:**

- automation of barriers, roller shutters, access control,
- automation of lighting installations,
- automation of compressors and air conditioning systems.

Their compact size and ease of setting-up make them a competitive alternative to solutions based on cabled logic or specific cards.

Simple programming, ensured by the universal nature of LADDER and function block diagram FBD (1) languages, meets all automation requirements and also the needs of the electrician.

Compact smart relays are suitable for simple automated systems, up to 20 I/O.

If required, modular smart relays can be fitted with I/O extensions and a module for communication on the Modbus network, for greater performance and flexibility, from 10 to 40 I/O.

### Programming

Programming can be carried out:

- independently, using the buttons on the smart relay (ladder language),
- on a PC, using "Zelio Soft" software.

When using a PC, programming can be carried out either in LADDER language, or in function block diagram language (FBD).

### LCD display backlighting (2)

Backlighting of the display is programmable using "Zelio Soft" software and by direct action on the smart relay's 6 programming buttons.

### Memory

The Zelio Logic smart relay has a backup memory which allows programs to be copied into another smart relay (examples: for building identical equipment, remote transmission of updates).

The memory also allows a backup copy of the program to be saved prior to exchanging the product.

When used with a smart relay without display or buttons, the copy of the program contained in the cartridge is automatically transferred into the smart relay at power-up.

### Autonomy and backup

Autonomous operating time of the clock, ensured by a lithium battery, is 10 years.

Data backup (preset values and current values) is provided by an EEPROM Flash memory (10 years).

### I/O extensions

Zelio Logic smart relays can, if necessary, take the following I/O extensions:

- 6, 10 or 14 I/O, supplied with  $\overline{\text{---}}$  24 V via the smart relay,
- 6, 10 or 14 I/O, supplied with  $\sim$  24 V via the smart relay,
- 6, 10 or 14 I/O, supplied with  $\sim$  100... 240 V via the smart relay.

### Communication module ▲

A module for communication on the Modbus network will be available for Zelio Logic modular smart relays. It is supplied with  $\overline{\text{---}}$  24 V via the smart relay.

### Communication interface ▲▲

The "communication" products in the Zelio Logic range include:

- a communication interface connected between a smart relay and a modem,
- analogue or GSM modems,
- "Zelio Soft Com" software.

They are designed for monitoring or remote control of machines or installations which operate without personnel.

The communication interface, supplied with  $\overline{\text{---}}$  12/24 V, allows messages, telephone numbers and call conditions to be stored.

(1) FBD: Functional Block Diagram.  
(2) LCD: Liquid Crystal Display

6



- 1 Modular smart relay (10 or 26 I/O)
- 2 I/O extension module (6,10 or 14 I/O)

▲ Available 1<sup>st</sup> quarter 2004.  
▲▲ Available 1<sup>st</sup> half 2004.

# Zelio Logic smart relays

Compact and modular smart relays

## Compact smart relays

Without display - 10, 12 and 20 I/O

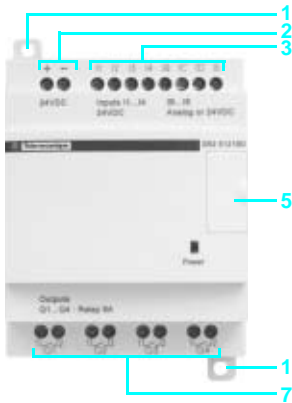

With display - 10, 12 and 20 I/O

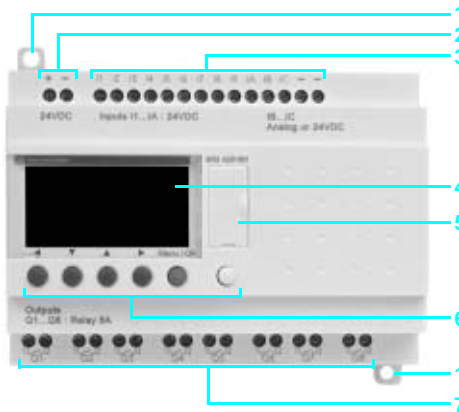

- Compact smart relays have the following on the front panel:
- 1 Two retractable fixing lugs
  - 2 Two power supply terminals
  - 3 Terminals for connection of the inputs
  - 4 Backlit LCD display with 4 lines of 18 characters
  - 5 Slot for a memory cartridge and connection to a PC
  - 6 6 buttons for programming and parameter entry
  - 7 Terminals for connection of the outputs

## Modular smart relays

10 and 26 I/O

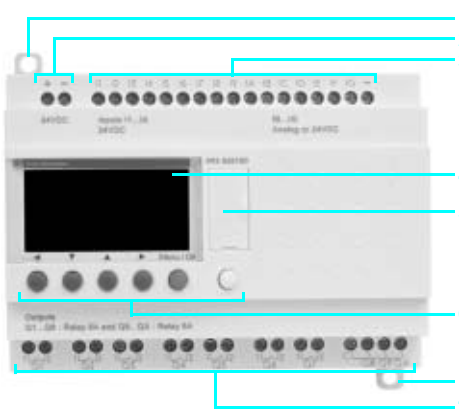

- Modular smart relays have the following on the front panel:
- 1 Two retractable fixing lugs
  - 2 Two power supply terminals
  - 3 Terminals for connection of the inputs
  - 4 Backlit LCD display with 4 lines of 18 characters
  - 5 Slot for a memory cartridge and connection to a PC
  - 6 6 buttons for programming and parameter entry
  - 7 Terminals for connection of the outputs

## I/O extension modules

6 I/O

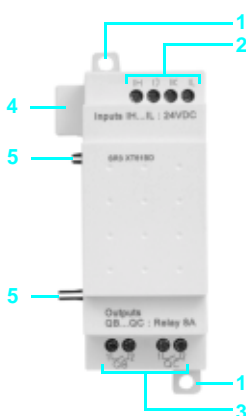

10 and 14 I/O

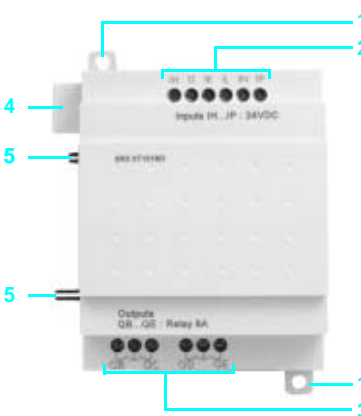

- I/O extension modules have the following on the front panel:
- 1 Two retractable fixing lugs
  - 2 Terminals for connection of the inputs
  - 3 Terminals for connection of the outputs
  - 4 A connector for connection to the smart relay (powered by the smart relay)
  - 5 Locating pegs

# Zelio Logic smart relays

## Compact and modular smart relays

### "Zelio Soft for PC" programming software

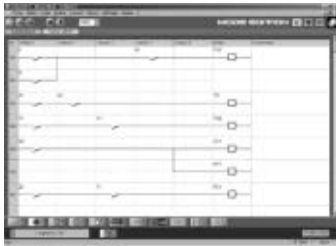

Programming in LADDER language

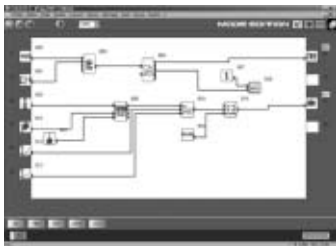

Programming in FBD language

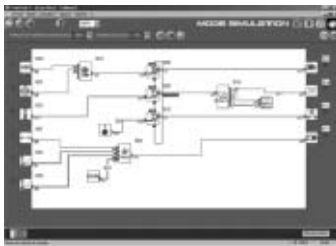

"Simulation" mode



"Monitoring" mode

#### "Zelio Soft for PC" (version 2.0)

"Zelio Soft" software allows:

- programming in LADDER language or in function block diagram language (FBD),
- simulation, monitoring and supervision,
- uploading and downloading of programs,
- output of personalised files,
- automatic compiling of programs,
- on-line help.

#### Coherence test and application languages

"Zelio Soft" software monitors applications by means of its coherence test function. An indicator turns red at the slightest input error. The problem can be located by simply clicking the mouse.

"Zelio Soft" software allows switching, at any time, to any of the 6 application languages (English, French, German, Spanish, Italian, Portuguese), and editing of the application file in the selected language.

#### Inputting messages for display on Zelio Logic

"Zelio Soft" software allows Text function blocks to be configured, which can then be displayed on all smart relays which have a display.

#### Program testing

2 test modes are provided: simulation and monitoring.

"Zelio Soft" **simulation** mode allows all the programs to be tested, without the smart relay, i.e.:

- enable discrete inputs,
- display the status of outputs,
- vary the voltage of the analogue inputs,
- enable the programming buttons,
- simulate the application in real time or in accelerated time,
- dynamically display (in red) the various active elements of the program.

"Zelio Soft" **monitoring** mode makes it possible to test the program executed by the smart relay, i.e.:

- display the program "on line",
- force inputs, outputs, control relays and current values of the function blocks,
- adjust the time,
- change from STOP mode to RUN mode and vice versa.

In simulation or monitoring mode, the monitoring window allows the status of the smart relay I/O to be displayed within your application environment (diagram or image).



### LADDER language

**Definition**



Text function block



Timer



Up/down counter



Fast counter



Analogue comparator



Clock



Control relay



Counter comparator



LCD backlighting



Summer/Winter time switching



Output coil

LADDER language allows a LADDER program to be written with elementary functions, elementary function blocks and derived function blocks, as well as with contacts, coils and variables. The contacts, coils and variables can be annotated. Text can be placed freely within the graphic.

**■ Control scheme input modes**







“Zelio input” mode enables users who have directly programmed the Zelio smart relay to find the same user interface, even when using the software for the first time. “Free input” mode, which is more intuitive, is very user-friendly and incorporates many additional features. With LADDER programming language, two alternative types of symbol can be used :

- LADDER symbols,
- electrical symbols.

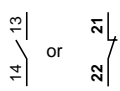
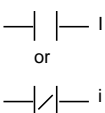
“Free input” mode also allows the creation of mnemonics and notes associated with with each line of the program. Instant switching from one input mode to the other is possible at any time, by clicking the mouse. Up to 120 control scheme lines can be programmed, with 5 contacts and 1 coil per program line.

**■ Functions:**

- 16 time delay function blocks; parameters of 11 different types can be set for each of these (1/10<sup>th</sup> second to 9999 hours),
- 16 up/down counter function blocks from 0 to 32767,
- 1 fast counter (1 kHz),
- 16 text function blocks,
- 16 analogue comparator function blocks,
- 8 clock function blocks, each with 4 channels,
- 28 control relays,
- 8 counter comparators,
- automatic Summer/Winter time switching,
- variety of coil functions, latching (Set/Reset), impulse relay, contactor
- LCD screen with programmable backlighting.

Function	Electrical scheme	LADDER language	Notes
<b>Contact</b>			I corresponds to the real state of the contact connected to the input of the smart relay. i corresponds to the inverse state of the contact connected to the input of the smart relay.
<b>Standard coil</b>			The coil is energised when the contacts to which it is connected are closed.
<b>Latch coil (Set)</b>			The coil is energised when the contacts to which it is connected are closed. It remains tripped when the contacts re-open.
<b>Unlatch coil (Reset)</b>			The coil is de-energised when the contacts to which it is connected are closed. It remains inactive when the contacts re-open.

## Function block diagram language (FBD) (1)





































### Definition

FBD language allows graphical programming based on the use of predefined function blocks.

This language provides the use of 23 pre-programmed functions for counting, time delay, timing, definition of switching threshold (temperature regulation for example), generation of impulses, time programming, multiplexing, display, etc.

### Pre-programmed functions

Zelio Logic smart relays provide a high processing capacity, up to 200 function blocks, including 23 pre-programmed functions:

 <p><b>TIMER AC</b> TIMER A/C Timer. Function A/C ON-delay and OFF delay</p>	 <p><b>TIMER BH</b> TIMER B/H Timer. Function BH. (Adjustable pulsed signal)</p>	 <p><b>TIMER BW</b> TIMER B/W Timer - Function B/W (pulse on rising/falling edge)</p>
 <p><b>TIMER Li</b> TIMER L/i Pulse generator ON-delay, OFF delay</p>	 <p><b>BISTABLE</b> BISTABLE Impulse relay function</p>	 <p><b>SET-RESET</b> Bistable latching - Priority assigned either to SET or RESET function</p>
 <p><b>BOOLEAN</b> BOOLEAN Allows logic equations to be created between connected inputs</p>	 <p><b>CAM</b> CAM Cam programmer</p>	 <p><b>PRESET COUNT</b> PRESET COUNT Up/down counter</p>
 <p><b>UP DOWN COUNT</b> UP DOWN COUNT Up/down counter with external preset</p>	 <p><b>PRESET H-METER</b> PRESET H-METER Hour counter (hour, minute preset)</p>	 <p><b>TIME PROG</b> TIME PROG Time programmer, weekly and annual</p>
 <p><b>GAIN</b> GAIN Allows conversion of an analogue value by change of scale and offset.</p>	 <p><b>TRIGGER</b> TRIGGER Defines an activation zone with hysteresis.</p>	 <p><b>MUX</b> MUX Multiplexing functions on 2 analogue values</p>
 <p><b>MAX COMP IN ZONE</b> MAX VAL MIN Zone comparison (Min. ≤ Value ≤ Max.)</p>	 <p><b>ADD/SUB</b> Add and/or subtract function</p>	 <p><b>MUL/DIV</b> Multiply and/or divide function</p>
 <p><b>DISPLAY</b> DISPLAY Display of digital and analogue data, date, time, messages for Human-Machine interface.</p>	 <p><b>COMPARE</b> COMPARE Comparison of 2 analogue values using the operands =, &gt;, &lt;, ≤, ≥.</p>	 <p><b>STATUS</b> STATUS Access to smart relay status</p>
 <p><b>ARCHIVE</b> ARCHIVE Storage of 2 values simultaneously</p>	 <p><b>SPEED COUNT</b> SPEED COUNT Fast counting up to 1 kHz</p>	
<h3>SFC functions (2) (GRAFSET)</h3>		
 <p><b>RESET-INIT</b> RESET-INIT Reinitialisable step</p>	 <p><b>INIT STEP</b> INIT STEP Initial step</p>	 <p><b>STEP</b> STEP SFC step</p>
 <p><b>DIV-OR 2</b> DIV-OR 2 Divergence to OR</p>	 <p><b>CONV-OR 2</b> CONV-OR 2 Convergence to OR</p>	 <p><b>DIV-AND 2</b> DIV-AND 2 Divergence to AND</p>
 <p><b>CONV-AND 2</b> CONV-AND 2 Convergence to AND</p>		
<h3>Logic functions</h3>		
 <p><b>AND</b> AND AND function</p>	 <p><b>OR</b> OR OR function</p>	 <p><b>NAND</b> NAND NOT AND function</p>
 <p><b>NOR</b> NOR NOT OR function</p>	 <p><b>XOR</b> XOR Exclusive OR function</p>	 <p><b>NOT</b> NOT NOT function</p>

(1) Functional Block Diagram.  
(2) Sequential Function Chart.

Environment characteristics			
Product certifications			UL, CSA, GL, C-TICK
Conformity with the low voltage directive	Conforming to 73/23/EEC		EN 61131-2
Conformity with the EMC directive	Conforming to 89/336/EEC		EN 61131-2 (Zone B) EN 61000-6-2, EN 61000-6-3 and EN 61000-6-4
Degree of protection	Conforming to IEC 60529		IP 20
Overvoltage category	Conforming to IEC 60664-1		3
Degree of pollution	Conforming to IEC/EN 61131-2		2
Ambient air temperature around the device	Operation	°C	-20... +55 (+40 in enclosure), conforming to IEC 60068-2-1 and IEC 60068-2-2
	Storage	°C	-40... +70
Maximum relative humidity			95 % without condensation or dripping water
Maximum operating altitude	Operation	m	2000
	Transport	m	3048
Mechanical resistance	Immunity to vibrations		IEC 60068-2-6, test Fc
	Immunity to mechanical shock		IEC 60068-2-27, test Ea
Resistance to electrostatic discharge	Immunity to electrostatic discharge		IEC 61000-4-2, level 3
Resistance to HF interference (Immunity)	Immunity to electromagnetic radiated fields		IEC 61000-4-3, level 3
	Immunity to fast transients in bursts		IEC 61000-4-4, level 3
	Immunity to shock waves		IEC 61000-4-5
	Radio frequency in common mode		IEC 61000-4-6, level 3
	Voltage dips and breaks (~)		IEC 61000-4-11
	Immunity to damped oscillation wave		IEC 61000-4-12
Conducted and radiated emissions	Conforming to EN 55022/11 (Group 1)		Class B
Connection to screw terminals (Tightened using Ø 3.5 screwdriver)	Flexible cable with cable end	mm <sup>2</sup>	1 conductor: 0.25...2.5, cable: AWG 24... AWG14 2 conductors: 0.25...0.75, cable: AWG 24... AWG18
	Semi-solid cable	mm <sup>2</sup>	1 conductor: 0.2...2.5, cable: AWG 25... AWG14
	Solid cable	mm <sup>2</sup>	1 conductor: 0.2...2.5, cable: AWG 25... AWG14 2 conductors: 0.2...1.5, cable: AWG 24... AWG16
	Tightening torque	N.m	0.5

--- 12 V supply characteristics				
Smart relay type			SR2 B121JD	SR2 B201JD
Primary	Nominal voltage	V	12	12
Voltage limits	Including ripple	V	10.4...14.4	10.4...14.4
Nominal input current		mA	120	200
Maximum nominal input current with extensions		mA	144	250
Power dissipated		WA	1.5	2.5
Micro-breaks	Permissible duration	ms	≤ 1 (repeated 20 times)	
Protection			Against polarity inversion	

--- 24 V supply characteristics											
Smart relay type			SR2 ●1●1BD	SR2 ●1●2BD	SR2 ●2●1BD	SR2 ●2●2BD	SR3 B101BD	SR3 B102BD	SR3 B261BD	SR3 B262BD	
Primary	Nominal voltage	V	24	24	24	24	24	24	24	24	
Voltage limits	Including ripple	V	19.2...30	19.2...30	19.2...30	19.2...30	19.2...30	19.2...30	19.2...30	19.2...30	
Nominal input current		mA	100	100	100	100	100	50	190	70	
Maximum nominal input current with extensions		mA	–	–	–	–	100	160	300	180	
Power dissipated		WA	3	3	6	3	3	4	6	5	
Maximum power dissipated with extensions		W	–	–	–	–	8	8	10	10	
Micro-breaks	Permissible duration	ms	≤ 1 (repeated 20 times)								
Protection			Against polarity inversion								

~ 24 V supply characteristics						
Smart relay type			SR2●1●1B	SR2●2●1B	SR3 B101B	SR3 B261B
Primary	Nominal voltage	V	24	24	24	24
Voltage limits	Including ripple	V	20.4...28.8	20.4...28.8	20.4...28.8	20.4...28.8
Nominal frequency		Hz	50-60	50-60	50-60	50-60
Nominal input current		mA	145	233	140	280
Power dissipated		VA	4	6	4	7.5
Micro-breaks	Permissible duration	ms	≤ 10 (repeated 20 times)			
rms insulation voltage		V	1780 (50-60 Hz)			

6

## ~ 100...240 V supply characteristics

Smart relay type			SR2 ●101FU	SR2 ●121FU	SR2 ●201FU	SR3 B101FU	SR3 B261FU
Primary	Nominal voltage	V	100...240	100...240	100...240	100...240	100...240
Voltage limits	Including ripple	V	85...264	85...264	85...264	85...264	85...264
Nominal input current		mA	80/30	80/30	100/50	80/30	100/50
Maximum nominal input current with extensions		mA	–	–	–	80/40	80/60
Power dissipated		VA	7	7	11	7	12
Maximum power dissipated with extensions		VA	–	–	–	12	17
Micro-breaks	Permissible duration	ms	10	10	10	10	10
rms insulation voltage		V	1780	1780	1780	1780	1780

## Processing characteristics

Smart relay type			SR2/SR3
Number of control scheme lines	With LADDER programming		120
Number of function blocks	With FBD programming		Up to 200
Cycle time		ms	10
Response time		ms	20
Back-up time (in the event of power failure)	Day/time		10 years (lithium battery) at 25 °C
	Program and settings		10 years (EEPROM memory)
Program memory checking			At each power-up
Clock drift			12 min/year (0 to 55 °C) 6 sec/month (at 25 °C and calibration)
Timer block accuracy			1 % ± 2 of the cycle time

## Discrete — 24 V input characteristics

Smart relay type			SR2/SR3
Connection			Screw terminal block
Nominal value of inputs	Voltage	V	24
	Current	mA	4
Input switching limit values	At state 1	Voltage	V ≥ 15
		Current	mA ≥ 2.20
	At state 0	Voltage	V ≤ 5
		Current	mA < 0.75
Input impedance at state 1		KΩ	7.4
Configurable response time	State 0 to 1	ms	0.2
	State 1 to 0	ms	0.3
Conformity to IEC 61131-2			Type 1
Sensor compatibility	3-wire		Yes PNP
	2-wire		No
Input type			Resistive
Isolation	Between supply and inputs		None
	Between inputs		None
Maximum counting frequency		kHz	1
Protection	Against inversion of terminals		Control instructions not executed

## Discrete ~ 100...240 V input characteristics

Smart relay type			SR2/SR3
Connection			Screw terminal block
Nominal value of inputs	Voltage	V	100... 240
	Current	mA	0.6
	Frequency	Hz	47... 63
Input switching limit values	At state 1	Voltage	V ≥ 79
		Current	mA > 0.1750
	At state 0	Voltage	V ≤ 40
		Current	mA < 0.05
Input impedance at state 1		KΩ	350
Configurable response time	State 0 to 1 (50/60 Hz)	ms	50
	State 1 to 0 (50/60 Hz)	ms	50
Isolation	Between supply and inputs		None
	Between inputs		None
Protection	Against inversion of terminals		Control instructions not executed

## Integral analogue input characteristics

Smart relay type			SR2/SR3
Analogue inputs	Input range	V	0...10 or 0...24
	Input impedance	KΩ	12
	Maximum non destructive voltage	V	30
	Value of LSB		39 mV, 4 mA
	Input type		Common mode
Conversion	Resolution		8 bit
	Conversion time		Smart relay cycle time
	Precision	at 25 °C	± 5 %
		at 55 °C	± 6.2 %
	Repeat accuracy	at 55 °C	± 2 %
Isolation	Between analogue channel and supply		None
Cabling distance		m	10 maximum, with screened cable (sensor not isolated)
Protection	Against inversion of terminals		Control instructions not executed

## Relay output characteristics

Smart relay type			SR2●●●/ SR3 B101●●	SR3 B261●●, SR3 XT141●●
Operating limit values		V	≐ 5...150. ~ 24...250	≐ 5...150. ~ 24...250
Contact type			N/O	N/O
Thermal current		A	8	8 outputs: 8 A 2 outputs: 5 A
Electrical durability for 500 000 operating cycles	Utilisation category	DC-12	V	24
			A	1.5
	DC-13	V	24 (L/R = 10 ms)	
		A	0.6	
	AC-12	V	230	
		A	1.5	
	AC-15	V	230	
		A	0.9	
Minimum switching capacity	At minimum voltage of 12 V	mA	10	10
Low power switching reliability of contact			12 V - 10 mA	12 V - 10 mA
Maximum operating rate	No-load	Hz	10	10
	At I <sub>e</sub> (operational current)	Hz	0.1	0.1
Mechanical life	In millions of operating cycles		10	10
Rated impulse withstand voltage	Conforming to IEC 60947-1 and 60664-1	kV	4	4
Response time	Trip	ms	10	10
	Reset	ms	5	5
Built-in protection	Short-circuit		None	
	Against overvoltage and overload		None	

## Transistor output characteristics

Smart relay type			SR2/SR3
Operating limit values		V	19.2...30
Load	Nominal voltage	V	≐ 24
	Nominal current	A	0.5
	Maximum current	A	0.625 at 30 V
Drop out voltage	At state 1	V	≤ 2 for I = 0.5 A
Response time	Trip	ms	≤ 1
	Reset	ms	≤ 1
Built-in protection	Against overload and short-circuits		Yes
	Against overvoltage (1)		Yes
	Against inversions of power supply		Yes

(1) If there is no volt-free contact between the relay output and the load.

## Electrical durability of relay outputs

(in millions of operating cycles, conforming to IEC 60947-5-1)

### d.c. loads

#### DC-12 (1)

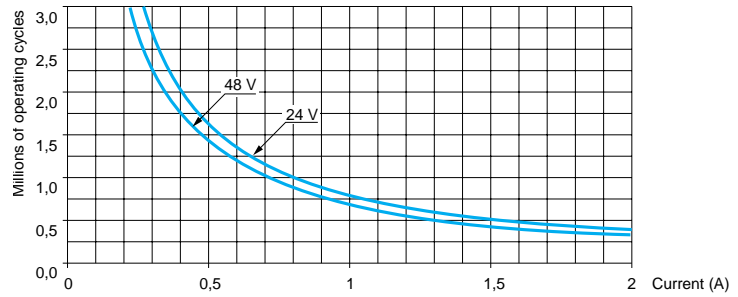

#### DC-13 (2)

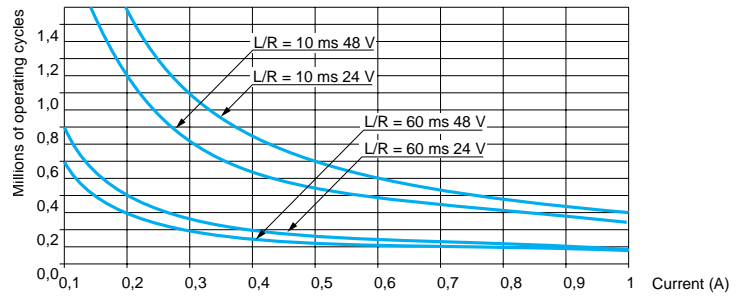

(1) DC-12: switching resistive loads and photo-coupler isolated solid state loads,  $L/R \leq 1\text{ms}$ .

(2) DC-13: switching electromagnets,  $L/R \leq 2 \times (U_e \times I_e)$  in ms,  $U_e$ : Rated operational voltage,  $I_e$ : rated operational current (with protection diode on load, use the DC-12 curves and apply a coefficient of 0.9 to the millions of operating cycles value)

# Zelio Logic smart relays

## Compact and modular smart relays

### Electrical durability of relay outputs (continued)

(in millions of operating cycles, conforming to IEC 60947-5-1)

#### a.c. loads

##### AC-12 (1)

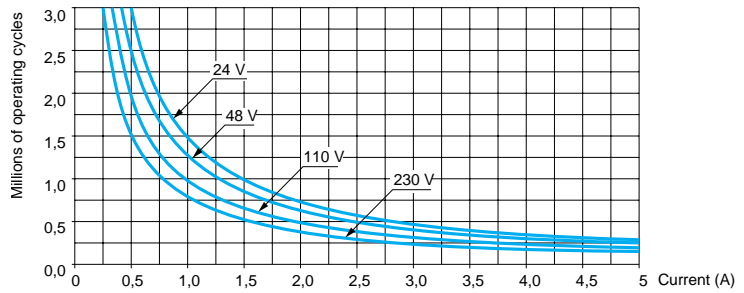

##### AC-14 (2)

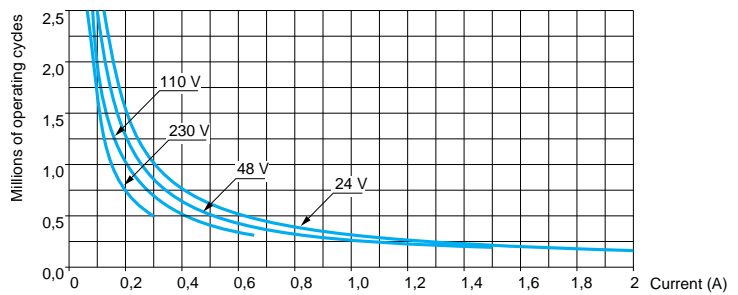

##### AC-15 (3)

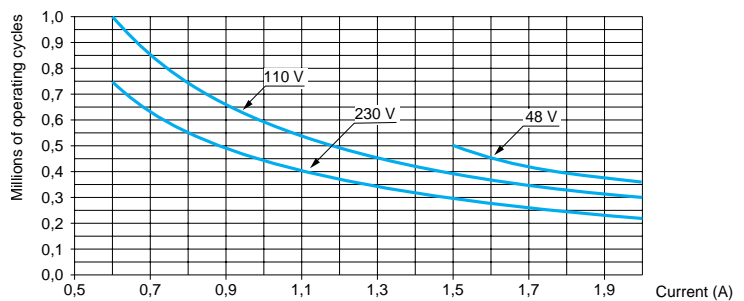

(1) AC-12: switching resistive loads and photo-coupler isolated solid state loads,  $\cos \geq 0.9$ .

(2) AC-14: switching small electromagnetic loads whose power drawn with the electromagnet closed is  $\leq 72$  VA, making:  $\cos = 0.3$ , breaking:  $\cos = 0.3$ .

(3) AC-15: switching electromagnetic loads whose power drawn with the electromagnet closed is  $> 72$  VA, making:  $\cos = 0.7$ , breaking:  $\cos = 0.4$ .

# Zelio Logic smart relays

## Compact smart relays



SR2 A201BD



SR2 E121BD



SR2 PACK...

### Compact smart relays with display

Number of I/O	Discrete inputs	Of which 0-10 V analogue inputs	Relay outputs	Transistor outputs	Clock	Reference	Weight kg
<b>Supply --- 12 V</b>							
12	8	4	4	0	Yes	SR2 B121JD	0.250
20	12	6	8	0	Yes	SR2 B201JD	0.250

<b>Supply --- 24 V</b>							
10	6	0	4	0	No	SR2 A101BD (1)	0.250
12	8	4	4	0	Yes	SR2 B121BD	0.250
	8	4	0	4	Yes	SR2 B122BD	0.220
20	12	2	8	0	No	SR2 A201BD (1)	0.380
	12	6	8	0	Yes	SR2 B201BD	0.380
	12	6	0	8	Yes	SR2 B202BD	0.280

<b>Supply ~ 24 V</b>							
12	8	0	4	0	Yes	SR2 B121B	0.250
20	12	0	8	0	Yes	SR2 B201B	0.380

<b>Supply ~ 100...240 V</b>							
10	6	0	4	0	No	SR2 A101FU (1)	0.250
12	8	0	4	0	Yes	SR2 B121FU	0.250
20	12	0	8	0	No	SR2 A201FU (1)	0.380
	12	0	8	0	Yes	SR2 B201FU	0.380

### Compact smart relays without display

Number of I/O	Discrete inputs	Of which 0-10 V analogue inputs	Relay outputs	Transistor outputs	Clock	Reference	Weight kg
<b>Supply --- 24 V</b>							
10	6	0	4	0	No	SR2 D101BD (1)	0.220
12	8	4	4	0	Yes	SR2 E121BD	0.220
20	12	2	8	0	No	SR2 D201BD (1)	0.350
	12	6	8	0	Yes	SR2 E201BD	0.350

<b>Supply ~ 24 V</b>							
12	8	0	4	0	Yes	SR2 E121B	0.220
20	12	0	8	0	Yes	SR2 E201B	0.350

<b>Supply ~ 100...240 V</b>							
10	6	0	4	0	No	SR2 D101FU (1)	0.220
12	8	0	4	0	Yes	SR2 E121FU	0.220
20	12	0	8	0	No	SR2 D201FU (1)	0.350
	12	0	8	0	Yes	SR2 E201FU	0.350

### Compact "discovery" packs

Number of I/O	Pack contents	Reference	Weight kg
<b>Supply --- 24 V</b>			
12	An SR2 B121BD compact smart relay with display, a connecting cable and "Zelio Soft" programming software supplied on CD-Rom.	SR2 PACKBD	0.700
20	An SR2 B201BD compact smart relay with display, a connecting cable and "Zelio Soft" programming software supplied on CD-Rom.	SR2 PACK2BD	0.850
<b>Supply ~ 100...240 V</b>			
12	An SR2 B121FU compact smart relay with display, a connecting cable and "Zelio Soft" programming software supplied on CD-Rom.	SR2 PACKFU	0.700
20	An SR2 B201FU compact smart relay with display, a connecting cable and "Zelio Soft" programming software supplied on CD-Rom.	SR2 PACK2FU	0.850

(1) Programming on smart relay in LADDER language only.



# Zelio Logic smart relays

## Modular smart relays



SR3 B101BD



SR3 XT61BD



SR3 XT141BD

### Modular smart relays with display

Number of I/O	Discrete inputs	Of which 0-10 V analogue inputs	Relay outputs	Transistor outputs	Clock	Reference	Weight kg
<b>Supply --- 24 V</b>							
10	6	4	4	0	Yes	SR3 B101BD	0.250
	6	4	0	4	Yes	SR3 B102BD	0.220
26	16	6	10 (1)	0	Yes	SR3 B261BD	0.400
	16	6	0	10	Yes	SR3 B262BD	0.300

### Supply ~ 24 V

10	6	0	4	0	Yes	SR3 B101B	0.250
26	16	0	10 (1)	0	Yes	SR3 B261B	0.400

### Supply ~ 100-240 V

10	6	0	4	0	Yes	SR3 B101FU	0.250
26	16	0	10 (1)	0	Yes	SR3 B261FU	0.400

### I/O extension modules (2)

Number of I/O	Discrete inputs	Relay outputs	Reference	Weight kg
<b>Supply --- 24 V (for smart relays SR3 B●●●BD)</b>				
6	4	2	SR3 XT61BD	0.125
10	6	4	SR3 XT101BD	0.200
14	8	6	SR3 XT141BD	0.220

### Supply ~ 24 V (for smart relays SR3 B●●●B)

6	4	2	SR3 XT61B	0.125
10	6	4	SR3 XT101B	0.200
14	8	6	SR3 XT141B	0.220

### Supply ~ 100-240 V (for smart relays SR3 B●●●FU)

6	4	2	SR3 XT61FU	0.125
10	6	4	SR3 XT101FU	0.200
14	8	6	SR3 XT141FU	0.220

### Communication module (2)

For use on	Supply voltage	Reference	Weight kg
Modbus network	--- 24 V	SR3 MBU01BD ▲	0.300

### Modular "discovery" packs

Number of I/O	Pack contents	Reference	Weight kg
<b>Supply --- 24 V</b>			
10	An SR3 B101BD modular smart relay, a connecting cable and "Zelio Soft" programming software supplied on CD-Rom.	SR3 PACKBD	0.700
26	An SR3 B261BD modular smart relay, a connecting cable and "Zelio Soft" programming software supplied on CD-Rom.	SR3 PACK2BD	0.850
<b>Supply ~ 100...240 V</b>			
10	An SR3 B101FU modular smart relay, a connecting cable and "Zelio Soft" programming software supplied on CD-Rom.	SR3 PACKFU	0.700
26	An SR3 B261FU modular smart relay with display, a connecting cable and "Zelio Soft" programming software supplied on CD-Rom.	SR3 PACK2FU	0.850

(1) Including 8 outputs at maximum current of 8 A and 2 outputs at maximum current of 5 A.  
 (2) Power supply to the I/O extension and communication modules is via the modular smart relays

**Note:** The smart relay and its associated extensions must have an identical voltage.

▲ Available: 1<sup>st</sup> quarter of 2004.

# Zelio Logic smart relays

## Compact and modular smart relays

### Separate components

510352



SR2 SFT01

#### “Zelio Soft” software for PC

Description	Reference	Weight kg
“Zelio Soft” for PC multi-language programming software supplied on CD-Rom (1), compatible with Windows 95, 98, NT, 2000, XP and ME.	SR2 SFT01	0.200
Connecting cable between smart relay and PC (length: 3 m)	SR2 CBL01	0.150

#### Back-up memory

Description	Reference	Weight kg
EEPROM back-up memory	SR2 MEM01	0.010

109369



SR2 MEM01

#### Communication interface (2)

Description	Supply	Reference	Weight kg
Communication interface	≡ 12/24 V	SR2 COM01 ▲	0.140

#### Converters for Optimum Pt100 probes (3)

Supply voltage ≡ 24 V (20 %, not isolated)

Type	Temperature range		Output signal	Reference	Weight kg
	°C	°F			
Pt100	- 40...40	- 40...104	0...10 V or 4...20 mA	RMP T13BD	0.116
2-wire, 3-wire and 4-wire	- 100...100	- 148...212	0...10 V or 4...20 mA	RMP T23BD	0.116
	0... 100	32... 212	0...10 V or 4...20 mA	RMP T33BD	0.116
	0... 250	32... 482	0...10 V or 4...20 mA	RMP T53BD	0.116
	0... 500	32...932	0...10 V or 4...20 mA	RMP T73BD	0.116

#### Power supplies (3)

Input voltage	Nominal output voltage	Nominal output current	Reference	Weight kg
~ 100...240 V (47...63 Hz)	≡ 12 V	1.9 A	ABL 7RM1202	0.180
	≡ 24 V	1.4 A	ABL 7RM2401	0.182

#### Documentation

Description	Language	Reference	Weight kg
User's manual for direct programming on the smart relay	English	SR2 MAN01EN	0.100
	French	SR2 MAN01FR	0.100
	German	SR2 MAN01DE	0.100
	Spanish	SR2 MAN01ES	0.100
	Italian	SR2 MAN01IT	0.100
	Portuguese	SR2 MAN01P0	0.100

(1) CD-Rom containing “Zelio Soft” software, an application library, a self-training manual, installation instructions and a user's manual.

(2) See pages 6/20 to 6/25

(3) See our catalogue “Interfaces, I/O splitter boxes and power supplies”.

510383



SR2 COM01

6

510354



ABL7 RM1202

▲ Available: 1<sup>st</sup> half of 2004.

## Compact and modular smart relays

SR2 A101BD, SR2 D101FU, SR3 B101BD and SR3 B101FU (10 I/O)  
 SR2 B121JD, SR2 B12●BD, SR2 B121B, SR2 A101FU, SR2 B121FU, SR2 D101BD, SR2 E121BD, SR2 E121B, SR2 E121FU (12 I/O)

Mounting on 35 mm  rail

Screw fixing (retractable lugs)

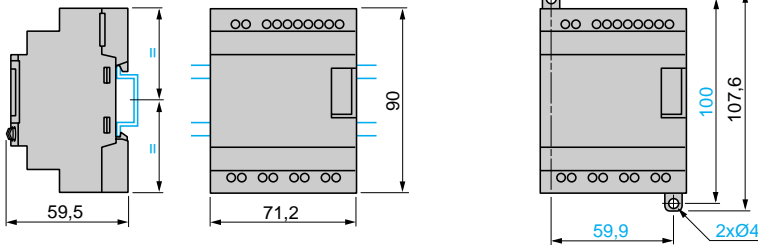

SR2 B201JD, SR2 A201BD, SR2 B20●BD, SR2 B201B, SR2 A201FU, SR2 B201FU, SR2 D201BD, SR2 E201BD, SR2 E201B, SR2 D201FU and SR2 E201FU (20 I/O)  
 SR3 B26●BD and SR3 B261FU (26 I/O)

Mounting on 35 mm  rail

Screw fixing (retractable lugs)

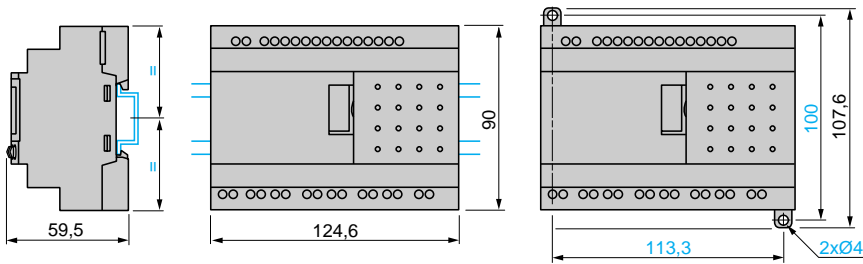

## I/O extension modules

SR3 XT61●● (6 I/O)

Mounting on 35 mm  rail

Screw fixing (retractable lugs)

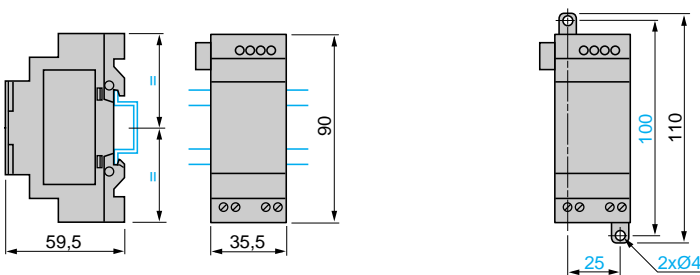

SR3 XT101●● and SR3 XT141●● (10 and 14 I/O)

Mounting on 35 mm  rail

Screw fixing (retractable lugs)

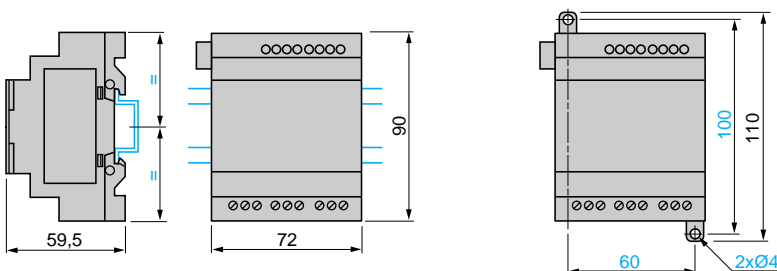

## Input connections

### 3-wire sensors

SR2 ●●●BD, SR2 B121JD and SR3 ●●●BD

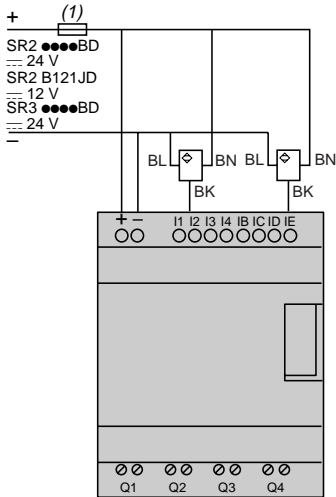

(1) 1 A quick-blow fuse or circuit-breaker.

### Analogue inputs

SR2 B12●BD, SR2 B121JD and SR3 B10●BD

SR2 B201BD, SR3 B26●BD and SR2 B201JD

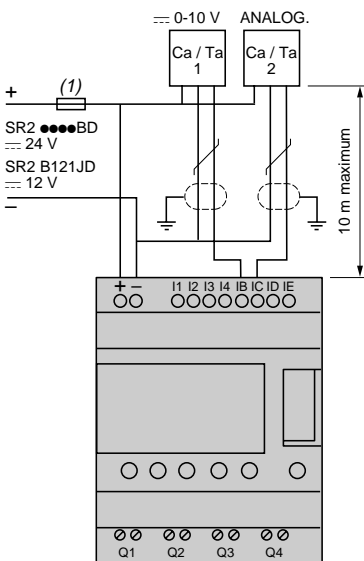

(1) 1 A quick-blow fuse or circuit-breaker.

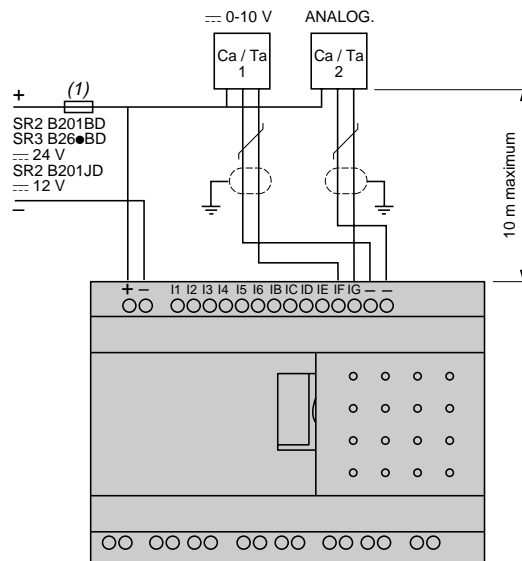

(1) 1 A quick-blow fuse or circuit-breaker.

6

## Connection of smart relays on $\text{---}$ supply

SR2 ●●●BD, SR2 B121JD, SR2 ●201BD and SR3 B10●●

SR2 B122BD and SR2 B202BD, SR3 B102BD and SR3 B262BD

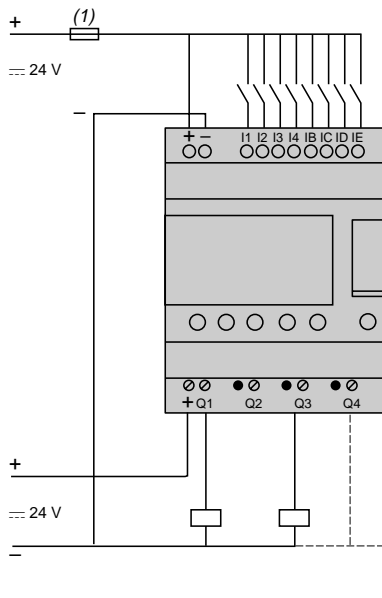
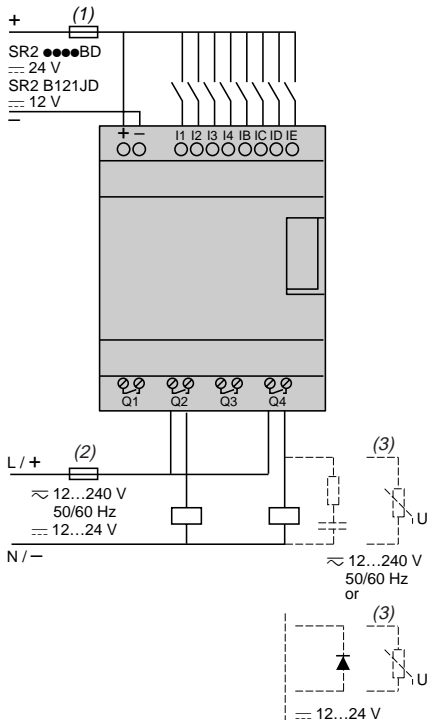

- (1) 1 A quick-blow fuse or circuit-breaker.
- (2) Fuse or circuit-breaker.
- (3) Inductive load.

- (1) 1 A quick-blow fuse or circuit-breaker.

## Connection of smart relays on $\sim$ supply

SR2 B●●B, SR2 A1●1FU, SR2 ●201FU, SR3 B●●B and SR3 B●●FU

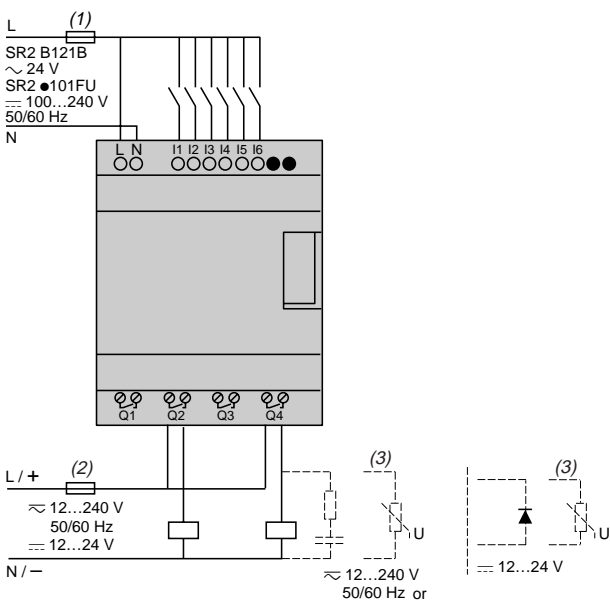

- (1) 1 A quick-blow fuse or circuit-breaker.
- (2) Fuse or circuit-breaker.
- (3) Inductive load.

# Analogue interfaces

## Zelio Analog

### Converters for thermocouples and Pt100 probes Voltage/current converters

The Zelio Analog range of converters is designed to convert signals emitted by sensors or electrical measurements into standard electrical signals which are compatible with automation platforms, controllers (thermal processes, speed, ...). They also allow the connection distance between a sensor and the measurement acquisition device to be increased: for example between a thermocouple and a programmable controller. Conforming to IEC standards, UL and CSA certified, these converters are suitable for universal use.

#### Measurement signals for thermocouples and Pt100 probes

The voltages induced by thermocouples vary between 10 and 80  $\mu\text{V}/^\circ\text{C}$ , Pt100 probes (100 ohms at 0  $^\circ\text{C}$ ) produce about 0.5  $\text{mV}/^\circ\text{C}$ , with measurement currents of 1 mA. Depending on the sensor, the signal to be measured ranges from a few  $\mu\text{V}$  (thermocouple) to 250 and 700 mV for a Pt100 probe.

It is therefore difficult to transmit these low level signals over long electric lines without encountering problems of interference, signal reduction or errors.

Connecting Zelio Analog converters close to the sensors resolves these problems :

- 4-20 mA current loops transmitted over a long distance are less sensitive to interference than low level voltage signals from sensors,
- signal reductions during transmission (resistance) of voltages do not occur,
- the cables used to connect the converters to process equipment (programmable controllers) are standard cables, which are more cost effective than extension cables or compensation cables suitable for low level signals for Pt100 probes or thermocouples.

#### Presentation

##### The Zelio Analog range

The Zelio Analog range has been developed both to take account of the most common applications and to ensure great simplicity of installation:

- pre-set input and output scales, requiring no adjustment
- outputs protected against reverse polarity, overvoltage and short-circuits
- --- 24 V power supply
- sealable protective cover
- rail mounting and screw fixing onto mounting plate
- LED indicator on the front panel
- input and output selector switches on the front panel
- output with fallback value if no input signal is present (due to failure of a sensor, for example).

The Zelio Analog converter range is divided into four families:

- Converters for J and K type thermocouples: **RMT J/K**
- Converters for Universal Pt100 probes: **RMP T $\bullet$ 0**
- Converters for Optimum Pt100 probes: **RMP T $\bullet$ 3**
- Universal voltage/current converters: **RMC**.

##### Converters for J and K type thermocouples

Thermocouples, which consist of two metals with different thermo-electric characteristics, produce a voltage that varies according to temperature. This voltage is transmitted to the Zelio Analog converter which converts it to a standard signal. Converters for thermocouples have cold junction compensation to allow detection of measurement errors induced by the connection to the device itself.

Converters for J and K type thermocouples have :

- for inputs, a pre-set temperature range, depending on the model:
  - Type J: 0...150  $^\circ\text{C}$ , 0...300  $^\circ\text{C}$ , 0...600  $^\circ\text{C}$
  - Type K: 0...600  $^\circ\text{C}$ , 0...1200  $^\circ\text{C}$ .
- for outputs, a switchable signal:
  - 0...10 V, 0... 20 mA, 4... 20 mA.

6



RMT J40BD



RMT K90BD

# Analogue interfaces

## Zelio Analog

Converters for thermocouples and Pt100 probes  
Voltage/current converters



RMP T70BD

### Converters for Universal Pt100 probes

Pt100 probes with platinum resistor are electrical conductors whose resistance varies according to the temperature. This ohmic resistance is transmitted to the Zelio Analog converter which converts it to a standard signal.

Converters for Universal Pt100 probes have:

■ for inputs, a pre-set temperature range, depending on the model:

- - 100...100 °C,
- - 40...40 °C,
- 0...100 °C,
- 0...250 °C,
- 0...500 °C.

■ for outputs, a switchable signal:

- 0... 10 V, 0... 20 mA, 4... 20 mA.

The products in the Universal Pt100 family allow wiring of Pt100 probes in 2, 3 and 4-wire mode.

### Converters for Optimum Pt100 probes

Derived from the above family, these converters have:

■ for inputs, a pre-set temperature range identical to that of converters for Universal Pt100 probes.

■ for outputs:

- a 0... 10V signal dedicated to Zelio Logic analogue inputs.

They allow Pt100 probes to be wired in 2, 3 and 4-wire mode.



RMC A61BD

### Universal voltage/current converters

This family of converters allows the adaptation of electrical values (voltage/current). Four products are available:

■ a cost effective converter which will convert a 0...10 V signal to a 4...20mA signal or vice versa.

■ a Universal voltage/current converter allowing the most common signals. They have:

□ for inputs, a voltage/current range:

- 0...10 V, ± 10 V, 0...20 mA, 4...20 mA.

□ for outputs, a switchable voltage/current range:

- 0...10 V, ± 10 V, 0...20 mA, 4...20 mA.

■ two Universal voltage/current converters which allow conversion of electrical power signals, both a.c. and d.c.

They have the following, depending on the model:

□ **for voltage inputs**, a range of 0 to 500 V (~ or =)

□ for outputs, a switchable voltage/current range:

- 0...10 V, 0...20 mA, 4...20 mA.

□ **for current inputs**, a range of 0 to 15 A (~ or =)

□ for outputs, a voltage/current range:

- 0...10 V, 0...20 mA, 4...20 mA.

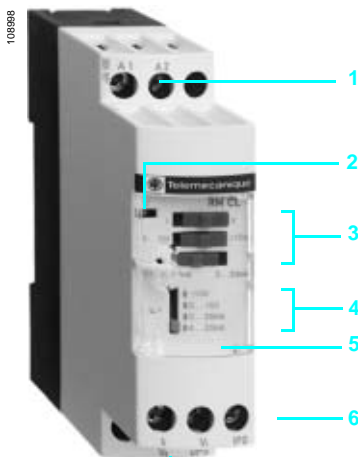

RMC L55BD

### Description

Zelio Analog converters have the following on their front panel, depending on the model:

- 1 Two terminals for = 24 V supply connection
- 2 A 'Power ON' LED
- 3 Three input selector switches (depending on model)
- 4 An output selector switch (depending on model)
- 5 A sealable protective cover
- 6 A screw terminal block for inputs
- 7 A screw terminal block for outputs.

# Analogue interfaces

## Zelio Analog

Converters for thermocouples and Pt100 probes  
Voltage/current converters

### Environment characteristics

Converter types		RMT J/K●●●●●, RMP ●●●●●, RMC●●●●●	
Conforming to standards		IEC 947-1, IEC 584-1 (IEC 751, DIN 43760 for RMP●●●●●)	
Approvals		UL, CSA, GL, CE	
Degree of protection			
	Housing	IP 50	
	Terminal block	IP 20	
Flame resistance	°C	850 conforming to UL, IEC 695-2-1	
Shock resistance		50 gn/11ms conforming to IEC 68-2-27	
Vibration resistance		5 gn (10...100 Hz) conforming to IEC 68-2-6	
Immunity to EMC			
	Resistance to electrostatic discharge	kV	Level 3: 8 (air), 6 (contact) conforming to IEC 1000-4-2
	Immunity to fast transient currents	kV	On the power supply: 2; on the input-output: 1 conforming to IEC 1004-4
	Surge withstand	kV	0.5 - waves 1.2/50µs; 0.5 J conforming to IEC 1000-4-5
Disturbance			
	Radiated/conducted	CISPR11 and CISPR22 Group1- Class B	
Insulation voltage		kV	2
Ambient air temperature around the device			
	Storage	°C	- 40...85 (- 40...185 °F)
	Operation	°C	Mounted side-by-side: 0...50 (32...122 °F); 2 cm spacing: 0...60 (32...140 °F)
Degree of pollution			2 conforming to IEC 60 664-1
Mounting			35 mm DIN rail, clip-on or fixed on mounting plate
Connection		mm <sup>2</sup>	2 x 1.5 or 1 x 2.5 cable
Tightening torque		Nm	0.6...1.1

### Specific characteristics

Types of converter for thermocouples		RMT J40BD	RMT J60BD	RMT J80BD	RMT K80BD	RMT K90BD
Input types	Thermocouple type, to IEC 584	J (Fe-CuNi)			K (Ni-CrNi)	
	Temperature range	°C	0...150	0...300	0...600	0...1200
		°F	32...302	32...572	32...1112	32...2192
Analogue output switchable to voltage or current						
Voltage	Range	V	0...10			
	Minimum impedance of load	kΩ	100			
Current	Range	mA	0...20; 4...20			
	Maximum impedance of load	Ω	500			
Built-in protection		Reverse polarity, overvoltage (± 30 V) and short-circuit				
Safety feature	Output state when no inputs are wired or when input wire broken	Output predetermined according to type of output selected: voltage = - 13 V current = 0 mA				
Supply						
Voltage	Rated	--- V	24 ± 20 %, non isolated			
Maximum current consumption	For voltage output	mA	40			
	For current output	mA	60			
Built-in protection		Reverse polarity				
Signalling		Green LED (power on)				
Measurements						
Accuracy	At 20 °C	%	± 1 of the full scale value			
Repeatability error	At 20 °C	%	± 0.25 of the full scale value			
	At 60 °C	%	± 0.8 of the full scale value			
Temperature coefficient		ppm/°C	200 (0.02 %)			
Cold junction compensation			Built-in, cold junction measurement: 0 to 60 °C (0...140 °F)			



# Analogue interfaces

## Zelio Analog

Converters for thermocouples and Pt100 probes

Voltage/current converters

<b>Specific characteristics (continued)</b>							
<b>Types of converter for Pt100 probes</b>		RMP T10/13BD	RMP T20/23BD	RMP T30/33BD	RMP T50/53BD	RMP T70/73BD	
<b>Input types</b>	Probe type	Pt100 - IEC 751; DIN 43760 (2, 3, 4-wire)					
	Temperature range	°C	- 40...40	- 100...100	0...100	0...250	0...500
		°F	- 40...104	- 148...212	32...212	32...482	32...932
<b>Analogue output</b>							
<b>Output selection</b>			0...10 V/0...20 mA, 4...20 mA switchable for RMP T●0BD				
			0...10 V or 4...20 mA for RMP T●3BD				
<b>Voltage</b>	Minimum impedance of load	kΩ	100				
<b>Current</b>	Maximum impedance of load	Ω	500				
<b>Built-in protection</b>			Reverse polarity, overvoltage (± 30 V) and short-circuit				
<b>Safety feature</b>	Output state when no inputs are wired or when input wire broken		Output predetermined according to type of output selected: voltage = - 13 V current = 0 mA				
<b>Supply</b>							
<b>Voltage</b>	Rated	--- V	24 ± 20 %, non isolated				
<b>Maximum current consumption</b>	For voltage output	mA	40				
	For current output	mA	60				
<b>Built-in protection</b>			Reverse polarity				
<b>Signalling</b>			Green LED (power on)				
<b>Measurements</b>							
<b>Accuracy</b>	At 20 °C	%	± 0.5 of the full scale value (3, 4-wire connection) ± 1 of the full scale value (2-wire connection)				
<b>Repeatability error</b>	At 20 °C	%	± 0.2 of the full scale value				
	At 60 °C	%	± 0.6 of the full scale value				
<b>Temperature coefficient</b>		ppm/°C	150 (0.015 %)				
<b>Connection in 2-wire mode</b>							
	Maximum resistance of cable	mΩ	200				
<b>Types of voltage/current converters</b>		RMC N22BD	RMC L55BD	RMC V60BD	RMC A61BD		
<b>Input types</b>	Voltage	V	--- 0...10	--- 0...10, ±10	0...50; 0...300; 0...500 --- or ~ 50/60 Hz	–	
	Current	mA	4...20	0...20; 4...20	–	–	
		A	–	–	–	0...1.5; 0...5; 0...15 --- or ~ 50/60 Hz	
<b>Analogue output</b>							
<b>Output selection</b>			By cabling	Switchable	Switchable	By cabling	
<b>Voltage</b>	Range	V	0...10	0...10; ± 10	0...10	0...10	
	Minimum impedance of load	kΩ	100				
<b>Current</b>	Range	mA	4...20	0...20; 4...20	0...20; 4...20	0...20; 4...20	
	Maximum impedance of load	Ω	500				
<b>Built-in protection</b>			Reverse polarity, overvoltage (± 30 V) and short-circuit				
<b>Safety</b>	Output state when no inputs are wired or when input wire broken		voltage: - 2.5 V current: 6 mA	voltage: - 10...+ 10 V = -10 V current: 0...+ 10 V = 0 V current: 0...20 mA = 0 mA 4...20 mA = 4 mA	voltage: 0 V current: 0...20 mA = 0 mA 4...20 mA = 4 mA		
<b>Supply</b>							
<b>Voltage</b>	Rated	V	--- 24 ± 20 % non isolated	--- 24 ± 20 % isolated (1.5 kV)			
<b>Maximum current consumption</b>	For voltage output	mA	40	70			
	For current output	mA	60	90			
<b>Built-in protection</b>			Reverse polarity				
<b>Signalling</b>			Green LED (power on)				
<b>Measurements</b>							
<b>Accuracy</b>	At 20 °C	%	± 1 of the full scale value		± 5 of the full scale value		
<b>Repeatability error</b>	At 20 °C	%	± 0.2 of the full scale value				
	At 60 °C	%	± 0.6 of the full scale value				
<b>Temperature coefficient</b>		ppm/°C	200 (0.02 %)			0...1.5 A: 500 (0.05 %) 0...5 A: 1000 (0.1 %) 0..0.15 A: 2000 (0.2 %)	

# Analogue interfaces

## Zelio Analog

Converters for thermocouples and Pt100 probes  
Voltage/current converters



RMT J40BD



RMT K90BD



RMP T70BD



RMP T13BD



RMC N22BD



RMC L55BD



RMC A61BD

### Converters for J and K type thermocouples

Supply voltage  $\approx 24\text{ V} \pm 20\%$ , non isolated

Type	Temperature range		Switchable output signal	Reference	Weight kg
	$^{\circ}\text{C}$	$^{\circ}\text{F}$			
Type J	0...150	32...302	0...10 V, 0...20 mA, 4...20 mA	RMT J40BD	0.120
	0...300	32...572	0...10 V, 0...20 mA, 4...20 mA	RMT J60BD	0.120
	0...600	32...1112	0...10 V, 0...20 mA, 4...20 mA	RMT J80BD	0.120
Type K	0...600	32...1112	0...10 V, 0...20 mA, 4...20 mA	RMT K80BD	0.120
	0...1200	32...2192	0...10 V, 0...20 mA, 4...20 mA	RMT K90BD	0.120

### Converters for Universal Pt100 probes

Supply voltage  $\approx 24\text{ V} \pm 20\%$ , non isolated

Type	Temperature range		Switchable output signal	Reference	Weight kg
	$^{\circ}\text{C}$	$^{\circ}\text{F}$			
Pt100 2-wire, 3-wire and 4-wire	-40...40	-40...104	0...10 V, 0...20 mA, 4...20 mA	RMP T10BD	0.120
	-100...100	-148...212	0...10 V, 0...20 mA, 4...20 mA	RMP T20BD	0.120
	0...100	32...212	0...10 V, 0...20 mA, 4...20 mA	RMP T30BD	0.120
	0...250	32...482	0...10 V, 0...20 mA, 4...20 mA	RMP T50BD	0.120
	0...500	32...932	0...10 V, 0...20 mA, 4...20 mA	RMP T70BD	0.120

### Converters for Optimum Pt100 probes (1)

Supply voltage  $\approx 24\text{ V} \pm 20\%$ , non isolated

Type	Temperature range		Output signal	Reference	Weight kg
	$^{\circ}\text{C}$	$^{\circ}\text{F}$			
Pt100 2-wire, 3-wire and 4-wire	-40...40	-40...104	0...10 V or 4...20 mA	RMP T13BD	0.120
	-100...100	-148...212	0...10 V or 4...20 mA	RMP T23BD	0.120
	0...100	32...212	0...10 V or 4...20 mA	RMP T33BD	0.120
	0...250	32...482	0...10 V or 4...20 mA	RMP T53BD	0.120
	0...500	32...932	0...10 V or 4...20 mA	RMP T73BD	0.120

### Universal voltage/current converters

Supply voltage  $\approx 24\text{ V} \pm 20\%$ , non isolated

Input signal	Output signal	Reference	Weight kg
0...10 V or 4...20 mA	0...10 V or 4...20 mA	RMC N22BD	0.120

Supply voltage  $\approx 24\text{ V} \pm 20\%$ , isolated

Input signal	Output signal	Reference	Weight kg
0...10 V, $\pm 10\text{ V}$ , 0...20 mA, 4...20 mA	Switchable: 0...10 V, $\pm 10\text{ V}$ , 0...20 mA, 4...20 mA	RMC L55BD	0.120
0...50 V, 0...300 V, 0...500 V $\approx$ or $\sim 50/60\text{ Hz}$	Switchable: 0...10 V, 0...20 mA, 4...20 mA	RMC V60BD	0.150
0...1.5 A, 0...5 A, 0...15 A $\approx$ or $\sim 50/60\text{ Hz}$	0...10 V or 0...20 mA or 4...20 mA	RMC A61BD	0.150

### Connection accessories

Description	Type	Sold in lots of	Unit reference	Weight kg
Terminal blocks for connection of protective earth conductor	Screw	100	AB1 RRTP435U	0.025
	Spring	100	AB1 RRTP435U2	0.015

(1) Converters dedicated to Zelio Logic smart relays.

# Analogue interfaces

## Zelio Analog

Converters for thermocouples and Pt100 probes  
Voltage/current converters

### Dimensions, mounting

RMT ●●●●/RMP ●●●●/RMC ●●●●

RMT ●●●●/RMC A61BD  
RMP ●●●●  
RMC ●●●●

Mounting on rails AM1 ●●●●

Panel mounting

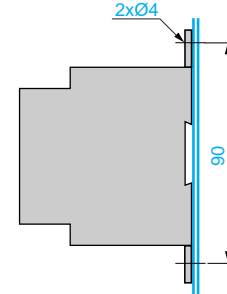
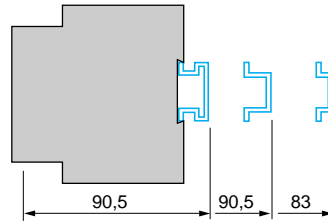
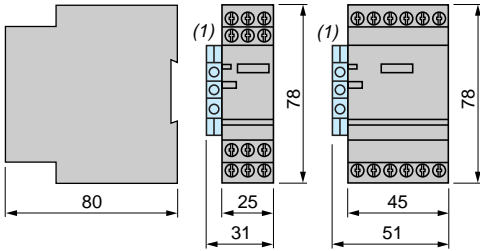

(1) Terminal block AB1 RRTP435U or AB1 RRTP435U2.

### Schemes

RMT J●●●, RMT K●●●

RMP T●0BD

RMP T●3BD

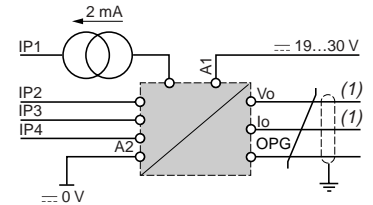
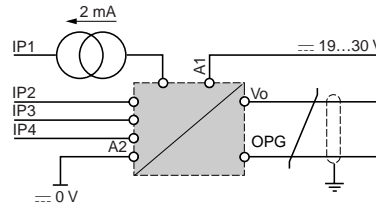
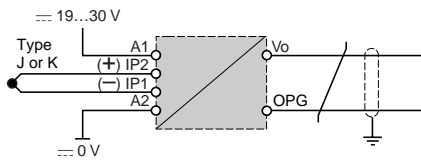

(1) Use one output only.

### Input connections on RMP T●●●●

2-wire type  
 $RL1 + RL2 \leq 200 \Omega$

3-wire type  
 $RL1 = RL2 = RL3$   
 $RL1 + RL2 \leq 200 \Omega$

4-wire type  
 $RL1 + RL2 \leq 200 \Omega$

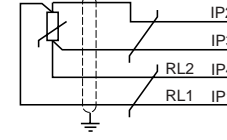
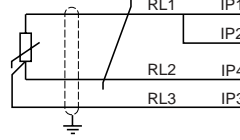
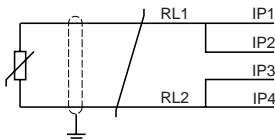

RMC ●●●●

RMC N22BD

RMC L55BD

RMC V60BD

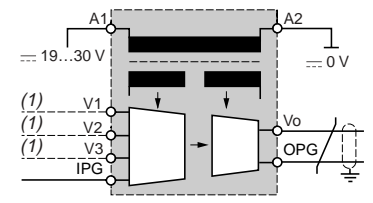
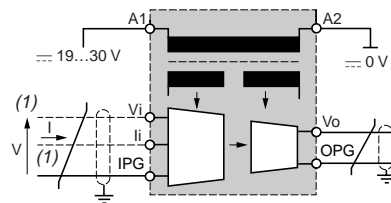
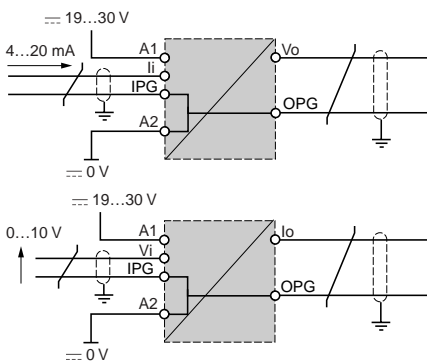

(1) Use one input only.

(1) Use one input only.

RMC A61BD

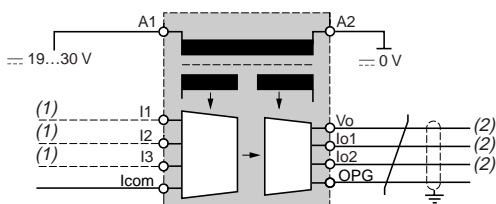

(1) Use one input only.  
(2) Use one output only.